

**EDGE**

**FUTURE POSSIBLE.  
AIR.  
SPACE.  
BEYOND.**

**EDGE PRODUCT LIST**





---

# TABLE OF CONTENTS



---

<b>WE ARE EDGE</b> .....	<b>4</b>
<b>OUR SOLUTIONS</b> .....	<b>6</b>
AUTONOMOUS .....	8
LAND SYSTEMS .....	42
NAVAL SYSTEMS.....	52
PRECISION GUIDED WEAPONS .....	60
MUNITIONS & AMMUNITION.....	76
SMALL ARMS .....	86
CYBER DEFENCE & SECURE COMMUNICATIONS.....	94
ELECTRONIC WARFARE .....	104
RADARS & ELECTRO OPTICS .....	118
SPACE .....	132
MRO.....	138
ENGINE & SUB-SYSTEMS .....	158
PRECISION ENGINEERING .....	164
TESTING & TRAINING SERVICES.....	172
HOMELAND SECURITY.....	192

# WE ARE EDGE



# ADVANCED TECHNOLOGY FOR DEFENCE & BEYOND

We live in an accelerating world. Characterised by uncharted frontiers, the future is empowered by advanced technology that is galvanising a new breed of players. At the edge of these frontiers exist no limits – where boundless opportunities await.

Transforming how we live, and ensuring a more secure future, is what we do. We are EDGE; and our mission is simple: to bring innovative technologies and services to market with greater speed and efficiency.

We are driving the development of sovereign capabilities for global export and for the preservation of national security, working with front-line operators, international partners, and adopting advanced technologies.

**We are EDGE. We enable a secure future.**

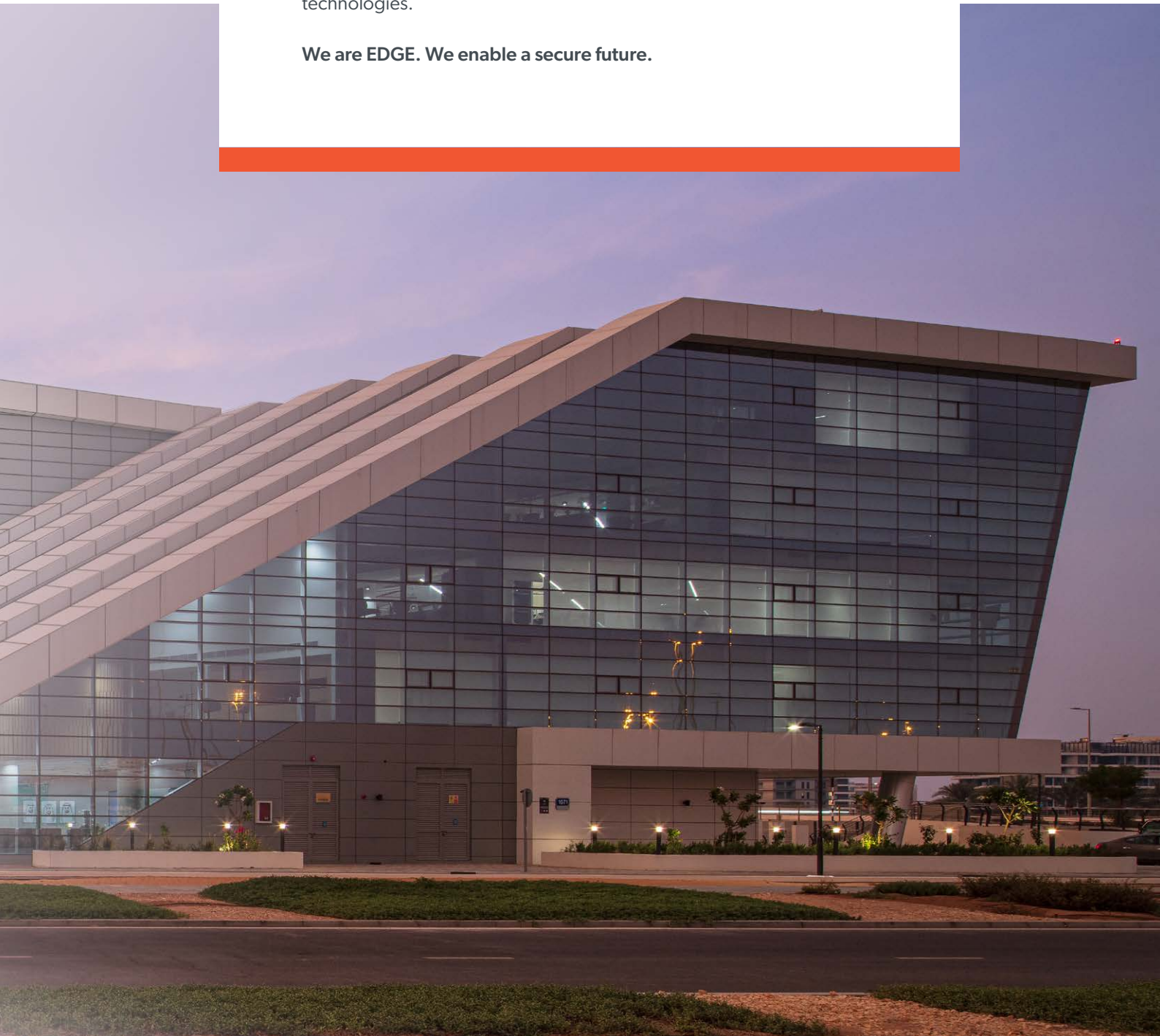

# OUR SOLUTIONS

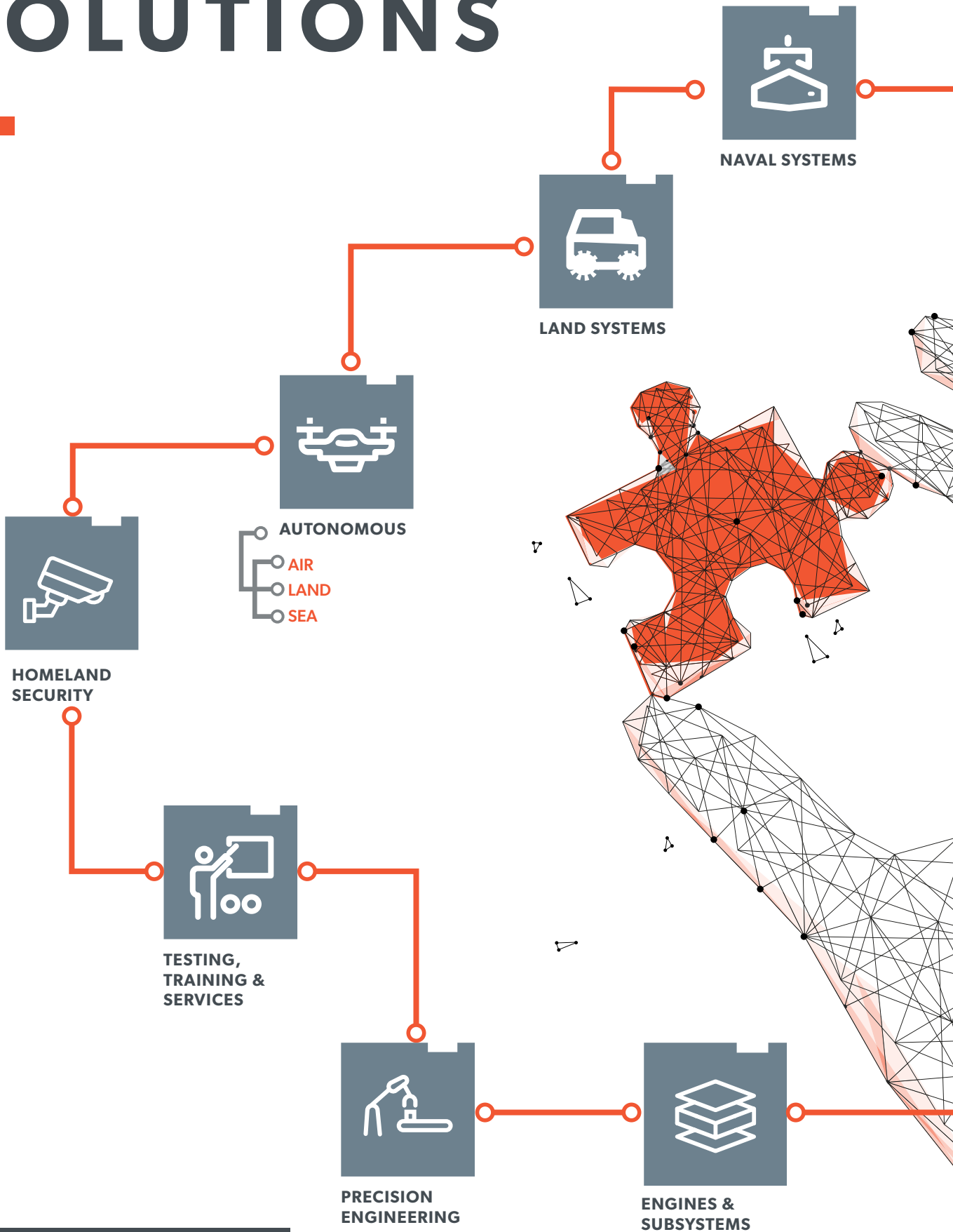

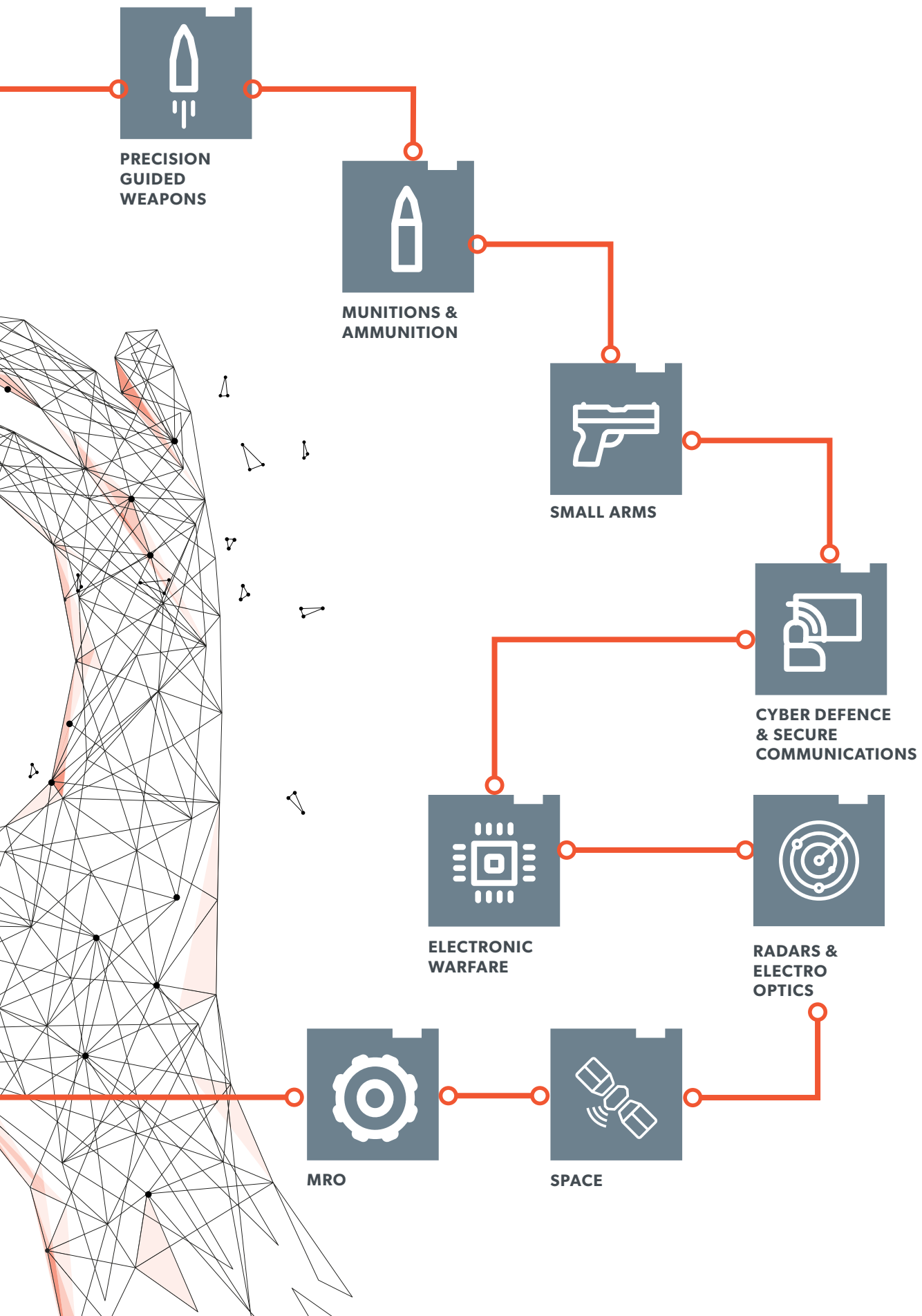

**EDGE**



**AUTONOMOUS**

**ADASI**

**ADVANCED**  
CONCEPTS

**ANAVIA**

**FLARIS**

 **MILREM**  
ROBOTICS

**ADSB**  
ABU DHABI SHIP BUILDING



# AUTONOMOUS

AIR | LAND | SEA

Bringing next-generation autonomous capabilities to air, land and sea domains to meet the expanding role for unmanned platforms in defence, national security, public safety and beyond.

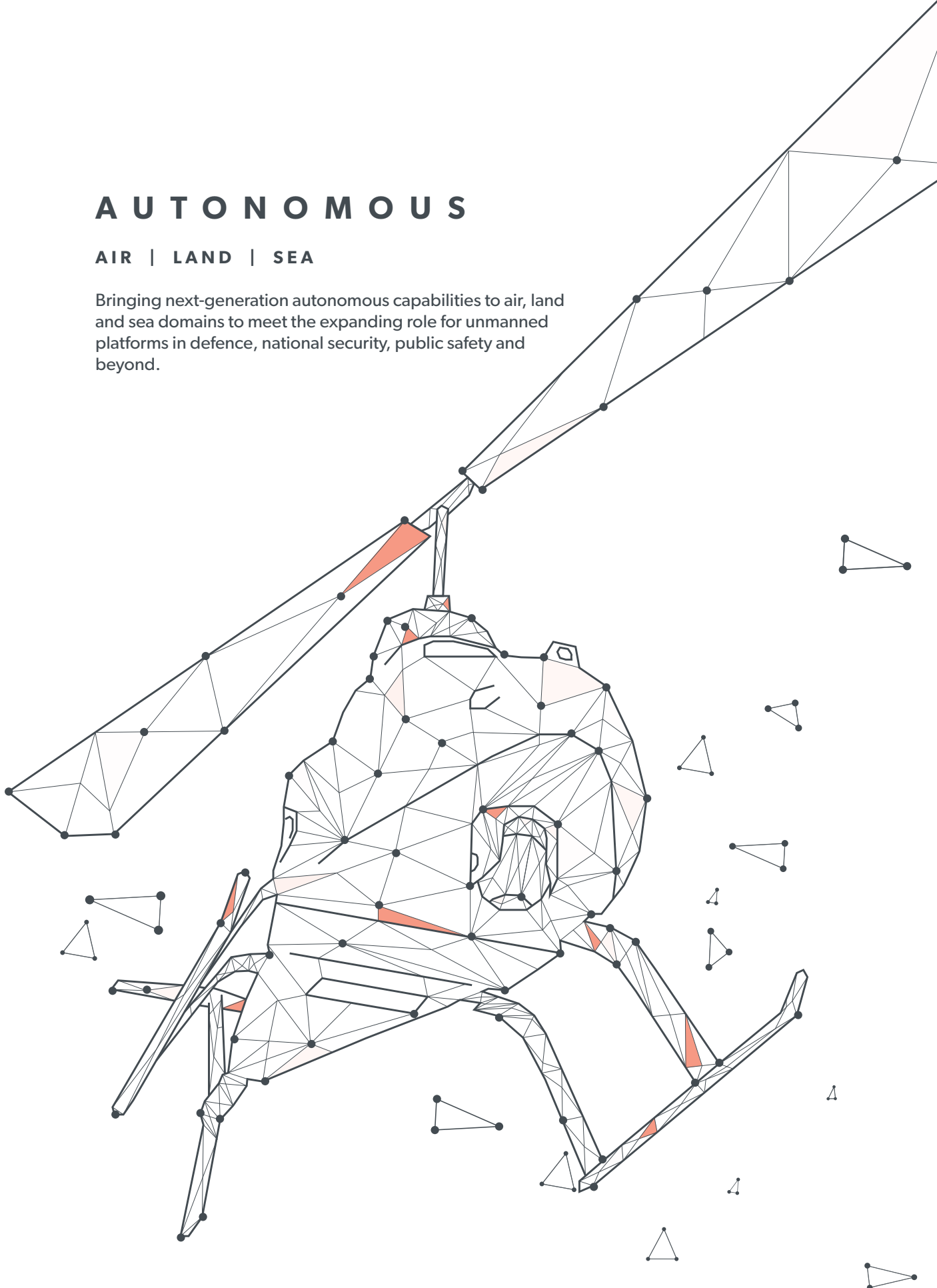

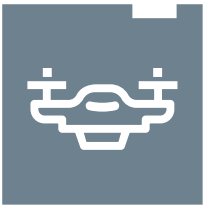

**AUTONOMOUS | AIR | ISR**  
**PRODUCTS**  
**ADASI**



### GARMOOSHA

A light unmanned aircraft designed to carry payloads of approximately 120 KG with an endurance of eight hours and 150 KM range.

**Range:** 150km

**Endurance:** 8 hours (including 30 minutes reserve)

**Payload:** 120kg

**Maximum speed:** 150km/h

**MTOW:** 540kg

**Ceiling altitude:** 10,000ft



FLYER



VIDEO



### QX-4

The QX-4 aerial vehicle is a modern tool for advanced intelligence, surveillance and reconnaissance (ISR) missions, featuring an extended endurance of up to 13 hours. With advanced autopilot and communication systems, the QX-4 can carry payloads of up to 7 kg, offering multiple mission scenarios to border control and military forces.

**Endurance:** 13hrs with 5kg Payload

**Payload max:** 7kg

**Data Link Range:** 150 km

**Max speed:** 140km/h

**Engine Type:**

VTOL: Electric

FWD: Gasoline



FLYER



VIDEO



**AUTONOMOUS | AIR | ISR**  
**PRODUCTS**  
**ADASI**

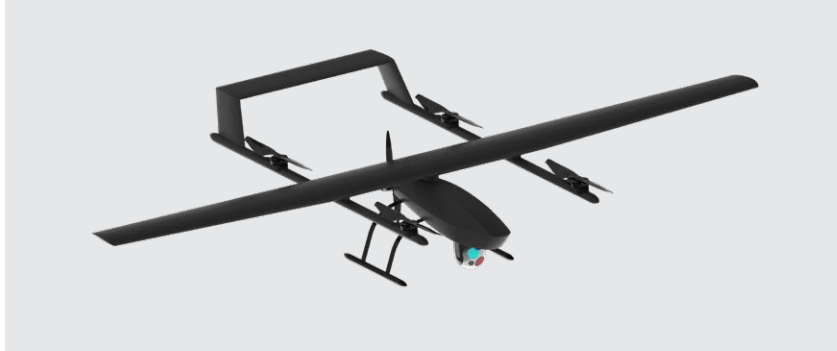

FLYER

## QX-5

The QX-5 aerial vehicle is a modern tool for advanced intelligence, surveillance and reconnaissance (ISR) missions, featuring an extended endurance of up to 16 hours. With advanced autopilot and communication systems, the QX-5 can carry payloads of up to 25 kg, offering multiple mission scenarios to border control and military forces.

**Endurance:** 16hrs

**Payload mass:** 25kg

**Data Link Range:** 150 km

**Max speed:** 160km/h

### Propulsion

VTOL: Electric

FWD: Gasoline



VIDEO

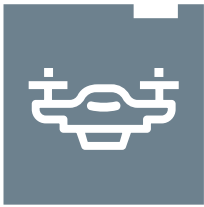

**AUTONOMOUS | AIR | ISR**  
**PRODUCTS**  
**EDGE**



FLYER

## PHANTOMDOCK

The PhantomDock is a tactical drone in a box system offering intelligence, surveillance and reconnaissance (ISR) capabilities to meet military, homeland security, and public safety requirements. With fully autonomous mission execution, a small footprint and simple logistics, the system is a powerful solution for multiple scenarios.

**Docking station size:** 2300mm x 750mm

**Maximum take-off weight:** 14kg

**Payload:** up to 5 kg

**Endurance** (with 0.5kg payload): 60 minutes

**Range:** 10 km

**Autonomous operation:** Take-off, landing, flight plan

**Drone battery capacity:** 864Wh

**Service ceiling:** 10,000ft



## PHANTOMHAWK

Designed from bottom up The PhantomHawk is an high performance tactical system designed for continuous, long-endurance missions, ensuring unmatched ease of deployment and seamless logistical with a vertical takeoff and landing (VTOL) capabilities. Tailored to meet today's high demands of Defence and Homeland Security operations, the PhantomHawk offers superior ISR operational capabilities.

**Maximum take-off weight:** 32kg

**Endurance:** 12hrs with 3.5kg payload

**Range:** Up to 150km (can be extended)

**Maximum Payload weight:** 7kg

**Engine type:** Hybrid eVTOL + IC

**Operating Temperature:** -20°C to 50°C

**Typical Operating Altitude:** 5,000ft

**Celling Altitude:** 12,000ft

**Wingspan:** 4.0m



**AUTONOMOUS | AIR | ISR**  
**PRODUCTS**  
**ANAVIA**



**HT-100**

The ANAVIA HT-100 unmanned helicopter provides robust, world-class and flexible capabilities to a wide range of military, border control, special forces, civil defence and law enforcement missions. This powerful system features a maximum flight endurance of 5 hours and 600km, and payload capacity of 65kg.

**MTOW:** 120kg

**Payload and fuel:** 65kg

**Max. speed:** 120km/h

**Operating ceiling**

(max. density altitude): 4,000m

**Communication range:** 200km



BROCHURE



VIDEO



**HT-750**

ANAVIA focuses on one key objective: ensuring customer satisfaction through innovative and reliable aircraft. With its endurance, cargo capacity and long range, the HT-750 stands as the world's leading heavy-lift unmanned VTOL system – ready for every mission, in every deployment.

**Payload and fuel** 750kg (1,654 lbs)

**Max. flight time** 15 hrs

**Max. airspeed** 222km/h (119 kn)

**Max. take-off weight** 1,150kg (2,536 lbs)

**Operating ceiling**

(max. density altitude): 4,000 m (13,123 ft)

**Max. flight mission/ payload weight:**

1 hrs/51kg      4 hrs/28kg

2 hrs/43kg      6 hrs/14kg



FLYER



**AUTONOMOUS | AIR | UCAV**  
**PRODUCTS**  
**FLARIS**



FLYER

## **SINYAR LARI**

The SINYAR unmanned aerial combat vehicle is capable of carrying weapons payloads of up to 750kg for longer-range and longer-endurance missions. Nimble enough to take off and land on short unpaved airstrips, SINYAR is a powerful mission-enablement platform for defence and special forces.

**MTOW:** 2,200kg

**Payload:** 450kg

**Cruise altitude:** 30,000ft

**Cruise speed:** 545km/h

**Communication system:** Satellite communication



**AUTONOMOUS | AIR | UCAV**  
**PRODUCTS**  
**FLARIS**

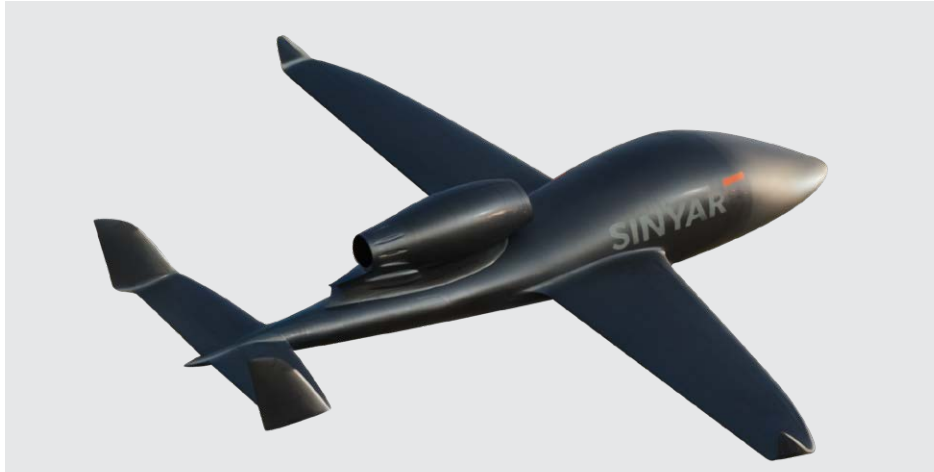

FLYER

## **SINYAR LAR3P**

The FLARIS SINYAR-LAR3P is a rapid-deployable, high-speed and 18-hour endurance unmanned aerial vehicle with both combat and ISR capabilities. Economical and easy to transport with detachable wings, the aircraft can climb rapidly (30m/sec) to quickly arrive at observation altitude and reduce speed for extended loitering.

With short take-off and landing capabilities, even from unpaved runways, the FLARIS SINYAR-LAR3P blends speed, endurance to perform intelligence, surveillance and reconnaissance tasks, maritime monitoring, search and rescue, electronic warfare and armed combat missions, and radio link transmission and retransmission.

**Wingspan:** 8.7m

**Length:** 8.3m

**MTOW:** 2,200kg

**Payload:** 610 kg

**Endurance (clean configuration):** 18 hours

**Range:** 6,000 km

**Max speed:** 650 km/h (TAS 350 kt)

**Max altitude:** 40,000 ft

**Communication System:** Satellite Communication

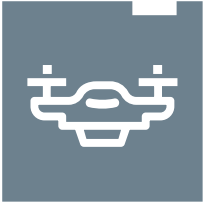

**AUTONOMOUS | AIR | UCAV**  
**PRODUCTS**  
**ADASI**



FLYER

## JENIAH

The ADASI JENIAH Collaborative Combat Aerial Vehicle is a high-speed, low-observable, unmanned combat aerial vehicle system capable of delivering various munition payloads. Designed to meet diverse mission requirements, the JENIAH system is a powerful asset for both land and sea operations and creates new opportunities to deliver payloads to strategic targets.

**MTOW:** 4,000kg

**Wingpan:** 7m

**Lenght:** 11m





**AUTONOMOUS | AIR | UCAV**  
**PRODUCTS**  
**ADASI**



FLYER

CLICK TO VIEW

## REACH - M

The ADASI REACH-M is a medium-altitude, long-endurance unmanned aerial vehicle capable of armed intelligence, surveillance and reconnaissance missions, as well as precision ground attacks.

**Dimensions:** 8.7m x 18.8m x 2.8m

**Endurance:** 29 hours (EOS only); 8 hours (EOS + weapon 8 x DS-16)

**MTOW:** 1,200 kg

**Payload:** 300 kg

**LOS datalink range:** 100 km

**Maximum speed:** 220 km



## REACH - S

Reach-S is a medium-altitude long-endurance unmanned combat aerial vehicle capable of autonomous flight operations.

**MTOW:** 640kg

**Max payload:** 120kg

**Ceiling:** 22,000ft

**Cruising speed:** 150 km/h

**Wing span:** 12m

**Length:** 6.4m

**Engine:** 110hp

**Endurance:** 24hrs

**Communication:** 200 Km LOS, Optional SATCOM





AUTONOMOUS | AIR | UCAV

PRODUCTS

ADASI



FLYER

## JEER

The ADASI JEER is a medium-altitude, long-endurance unmanned compact aerial vehicle suitable for tactical intelligence, surveillance and reconnaissance, as well as ground attacks.

**Dimensions (L x W x H):** 8m x 4m x 1.8m

**MTOW:** 600 kg

**Maximum load:** 100 kg

**Flying speed:** 220 km/h

**Maximum ceiling:** 15,000 ft

**Endurance:** 15 hours

**Communication:** 200 km LOS and SATCOM (optional)

**Frame material:** Composite



**AUTONOMOUS | AIR | AIR DEFENCE**  
**PRODUCTS**  
**ADASI**



FLYER

## SHADOW 3

The ADASI Shadow 3 is a portable vertical take-off and landing drone with GPS anti-jamming that offers dual mission functionality as a counter-measure drone or guided strike munition. It has a range of more than 30 km, endurance of up to 20 minutes, and maximum speeds of 200+ k/hr to 400+ k/hr, depending on propulsion system.

**Length:** 1m – 2.5m

**Wingspan:** 0.5m – 2.0m

**Maximum take-off weight:** +12 kg

**Range:** +30 km

**Endurance:** up to 20 minutes

**Payload:** 3 kg

**Maximum speed:** 200+ k/hr to 400+ k/hr

**Engine:** Electric / turbine jet

**Guidance:** GNSS / optical seeker

**Launcher:** Electric propulsion from stationary position

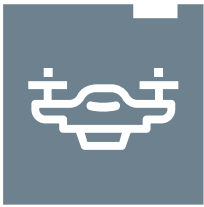

**AUTONOMOUS | AIR | AIR DEFENCE**  
**PRODUCTS**  
**ACASI**



FLYER

### SHADOW 25

The shadow 25 loitering unmanned aerial vehicle (UAV) system provides defence forces with a jet-powered, rapid-strike loitering munition capable of delivering a precision strike against fixed targets.

**MTOW:** 103 kg

**Empty Weight:** 37 kg (without fuel or payloads)

**Fuel Weight:** 41 kg (51 ltr)

**Payload:** 25 kg

**Operational Speed:** 450 km/hr

**Communication link range:** 100 km

**Endurance:** 60 minutes

**Wingspan:** 2.17m

**Length:** 2.25m

**MTOW:** 103kg

**Rate of Climb:** 2500 feet/minute at Mean Sea Level MTOW

Propulsion: Jet Engine, 450N thrust (rated)

Electric Power: Battery



VIDEO



FLYER

### SHADOW 50

The SHADOW 50 loitering unmanned aerial vehicle (UAV) system provides defence forces with a powerful, long-endurance, loitering munition that delivers precision strike capabilities against fixed targets.

**MTOW:** 125 kg

**Empty Weight:** 43 kg (without fuel or payload)

**Fuel Weight:** 62 kg (84 L)

**Payload:** <50kg

**Operational Speed:** 176km/hr

**Link range:** 100 km

**Endurance:** 9 Hours (With 25KG warhead)

**Altitude:** 12,500 ft.

**Rate of Climb:** 1100 feet/minute at Mean Sea Level MTOW

Propulsion: Internal combustion, gasoline-oil premix

Electric Power: Battery



VIDEO



**AUTONOMOUS | AIR | AIR DEFENCE**  
**PRODUCTS**  
**ADASI**



FLYER

### QX-1 LOITERING MUNITIONS

The QX-1 loitering munitions system offers military forces a compact, highly effective tool for discreet and precise targeted attacks. Lightweight and portable, this system includes various fuse options to adapt to any mission requirement.

**Range:** 10km

**Endurance:** 20 min

**Payload mass:** 0.5kg

**Engine type:** Electric

**Max Speed:** 18m/s



VIDEO



FLYER

### QX-2 LOITERING MUNITIONS

The QX-2 loitering munitions system offers military forces a compact, highly effective tool for discreet and precise targeted attacks. Lightweight and portable, this system includes various fuse options to adapt to any mission requirement.

**Range:** 20km

**Endurance:** 30 min

**Payload mass:** 2.5kg

**Engine type:** Electric

**Max Speed:** 18m/s



VIDEO



**AUTONOMOUS | AIR | AIR DEFENCE**  
**PRODUCTS**  
**ADASI**



FLYER



VIDEO

### **QX-3 LOITERING MUNITIONS**

The QX-3 loitering munitions system provides infantry and special forces with a powerful aerial capability via a 20kg UAV that can carry up to four precision-guided munitions. Equipped with onboard video and multiple weapons, the system enables operators to adapt to changing situations in real time, delivering strong support to ground operations.

**Range:** 40km

**Endurance:** 40 min

**Payload mass:** 6kg

**Max Speed:** 18m/s



**AUTONOMOUS | AIR | AIR DEFENCE**  
**PRODUCTS**

**ADVANCED**  
CONCEPTS



BROCHURE

## **HUNTER SP (SOLDIER PORTABLE)**

The Hunter SP possess a take-off weight of 4kg and can be fired from a portable launcher. It carries a payload of 0.6kg. The drone is suitable for recon and attack missions, operating at a cruising speed of 30m/s, with an endurance of 25 minutes. It features a wing span of 1m, length of 0.8 m and run by an electrical engine.

**Length:** 0.8m

**Wingspan:** 1m

**Payload:** 0.6 kg

**Range:** up to 30 km

**Cruise speed:** 30m/s

**MTOW:** up to 4k

**Fragmentation Lethality:** 5m radius

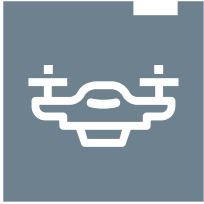

**AUTONOMOUS | AIR | AIR DEFENCE**  
**PRODUCTS**

**ADVANCED**  
CONCEPTS



FLYER



VIDEO

## HUNTER 2-S

The HUNTER 2-S is a fixed-wing, tube launched loitering munition, providing aerial strike capabilities at up to 50km from the launch point. The HUNTER 2-S autonomously flies to an intended target area and loiters while searching for targets. Once a target is identified, a remote pilot designates the target and activates engagement via man-in-the-loop control.

**Length:** Up to 1.3

**Wingspan:** Up to 2.2m

**Endurance:** 45 min

**Payload:** Up to 2kg

**Range:** Up to 50km

**Cruise speed:** 25m/s

**Fragmentation Lethality:** 10m radius

**Penetration:** 100mm



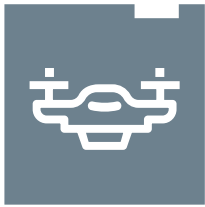

## AUTONOMOUS | AIR | AIR DEFENCE PRODUCTS

**ADVANCED**  
CONCEPTS



FLYER

### HUNTER-AR

The ADVANCED CONCEPTS Hunter-AR is an autonomous air-launched, fixed-wing loitering munition that carries a 10kg warhead.

With a 50km maximum range and 30-minute endurance, the platform provides an effective standoff capability that is complemented by GNSS guidance. This low-cost system features foldable wings for ease of transport and storage.

**Wingspan:** 2,600mm

**Length:** 1,800mm

**MTOW:** 25kg

**Endurance:** 30 min

**Cruising speed:** 30m/s

**Operational altitude:** 20,000ft

**Propulsion system:** Electric motor

**Maximum range:** 50km

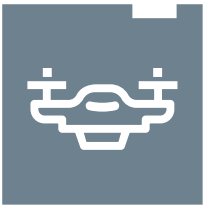

## AUTONOMOUS | AIR | AIR DEFENCE PRODUCTS

**ADVANCED**  
CONCEPTS



FLYER

### HUNTER 5

The HUNTER 5 possess a take-off weight of 50kg and can be fired from the back of an armoured vehicle. It carries a payload of 5kg. The drone flies at a maximum altitude of 7000ft. The drone is suitable for recon and attack missions, operating at a cruising speed of 120km/hr, with endurance of 180 minutes. It features a wing span of 3.6m, length of 2.85m and run by a gasoline engine..

**Length:** 2.5m

**Wingspan:** 3m

**Endurance:** 150 min

**Payload:** Up to 5kg

**Range:** Up to 100km

**Cruise speed:** 33m/s



VIDEO

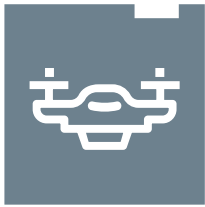

## AUTONOMOUS | AIR | AIR DEFENCE PRODUCTS

**ADVANCED**  
CONCEPTS



FLYER

### HUNTER 10

The HUNTER 10 is a container-launched, fixed-wing, tube launched loitering munitions that provide aerial strike capabilities on a designated target up to 100km from the launch point. The loitering munitions fly autonomously to an intended target area and loiter while searching for targets. Once a target is identified, a remote pilot designates the target and activates engagement via man-in-the loop control.

**Length:** 2.5m

**Wingspan:** 3m

**Endurance:** 150 min

**Payload:** 10 kg

**Range:** Up to 100 km

**Cruise speed:** 33m/s



VIDEO

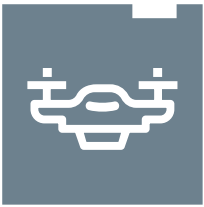

# AUTONOMOUS | AIR | AIR DEFENCE PRODUCTS

**ADVANCED**  
CONCEPTS



FLYER

## FAST RESPONDER 20/35/200

	FR-20	FR-35	FR-200
<b>MTOW:</b>	125kg	250kg	620kg
<b>Payload:</b>	20kg	35kg	200kg
<b>Endurance:</b>	30 min	30 min	30 min
<b>Cruise Speed:</b>	150 m/s	150 m/s	150 m/s
<b>Operational altitude:</b>	20000ft	20000ft	20000ft
<b>Propulsion system:</b>	Jet engine	Jet engine	Jet engine
<b>Maximum Range:</b>	270km	270km	270km



## AUTONOMOUS | AIR | AIR DEFENCE PRODUCTS

**ADVANCED**  
CONCEPTS

### FLY-X

The ADVANCED CONCEPTS FLY-X loitering munition is ideal for targeting enemy infantry or lightly armoured vehicles. Effective in contested environments, the FLY-X features inertial navigation in GPS-denied and counter-drone environments.

With a maximum range of 30 km and endurance up to 30 minutes, this ground-launched system is ideal for infantry and special forces looking to gain an advantage with an eyes-on, stand-off weapon. The platform, which incorporates an onboard ballistic calculator for extended range drops, can carry and deliver a fragmentation or penetration warhead weighing up to 2.5 kg.

**Maximum range:** 30 km

**Endurance:** 30 minutes

**Maximum warhead payload:** 2.5 kg

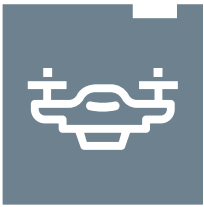

## AUTONOMOUS | AIR | AIR DEFENCE PRODUCTS

**ADVANCED**  
CONCEPTS

### ALLAG-TJ

The ADVANCED CONCEPTS ALLAG-TJ is a counter-drone system that provides protection against hostile aircraft operating at high altitudes, whether reconnaissance drones, loitering munitions, multirotor UAVs or other threats.

The ground-to-air system is designed to detect and intercept aerial vehicles operating at speeds up to 720km/h at altitudes from 3,000m (9,900ft) to 7,600m (25,000ft). The warhead offers fragmentation and cutting disc charge for enhanced lethality.

**Wingspan:** 340mm (700mm tail unfolded)

**Length:** 1,650mm (without booster)

**MTOW:** 25kg aircraft, 29kg with booster

**Total available flight time:** 5 +/- 1 min depending on mission profile

**Cruise speed:** 720km/h (depending on altitude)

**Max altitude:** 25,000ft (7,600m)

**Engine:** 32kg turbojet

**Communication range (LOS):** Up to 60km

**Payload:** 5kg

**Warhead type:** Fragmentation, cutting disc

**Lethal Radius:** 10m

**Target Accuracy:** <10m

**Navigation:** Ground-guided in cruise, self-guiding in terminal phase (seeker system)



FLYER



**AUTONOMOUS | AIR | AIR DEFENCE**  
**PRODUCTS**  
**ADVANCED**  
CONCEPTS

## ALLAG -E

The ADVANCED CONCEPTS ALLAG-E is a counter-drone system that provides protection against hostile aircraft operating at low altitudes, whether reconnaissance drones, loitering munitions, multirotor UAVs or other aerial threats.

The ground-to-air system is designed to detect and intercept aerial vehicles operating at speeds up to 200km/h at altitudes up to 3,000m (9,900ft). It features a 1.7kg warhead with fragmentation and cutting disk charge and proximity sensor. The system is operational, even in anti-jamming environment, through an RF link in guided mode and optical flow in attack mode.

**Wingspan:** 600mm

**Length:** 900mm

**MTOW:** 8.5kg

**Total available flight time:** 6+ min

**Cruising speed:** 250+ km/h

**Maximum altitude:** 3,000m

**Engine:** 2 x EDF (electric-ducted fan)

**Communication range (LOS):** 30 km

**Payload:** 1.7kg

**Warhead type:** Fragmentation, cutting disk

**Fragmentation Lethal Radius:** 5+ m

**Target Accuracy:** <10m

**Navigation:** Ground-guided in cruise, self-guiding in attack

**Operation in Anti-Jamming Environment:** RF link in guided mode, optical flow in attack mode

**Max airspeed:** 250+ km/h

**Endurance:** up to 8 minutes

**Maximum altitude:** 3,000+ m



FLYER



**AUTONOMOUS | AIR | AIR DEFENCE**  
**PRODUCTS**  
**EDGE**



FLYER

## HUNTER N

The HUNTER-N is a fixed wing, tube launched loitering munition designed for tactical naval operations. Launched from a portable container, the HUNTER-N offers rapid strike capabilities against naval targets up to 30km from the launch point. The loitering munitions fly autonomously to an intended target area and loiters while searching for targets. Once a target is identified, a remote pilot designates the target and activates engagement via man-in-the-loop control.

**MTOW:** Up to 8kg

**Payload:** 1kg

**Endurance:** 12 minutes

**Cruising Airspeed:** 25m/s

**Wingspan:** 1.9m

**Length:** 1.3m





**AUTONOMOUS | AIR | LOGISTICS**  
**PRODUCTS**  
**ADASI**



FLYER



VIDEO

## **QX6-50 CARGO UAV**

The QX6-50 is a swift, medium size, mid-range, unmanned helicopter capable of transporting payloads up to 50kg, which features advanced autopilot and communication systems. With an endurance of up to 3.5 hours, delivery radius of 200km, and the ability to land on multiple terrains, including sand and seagoing vessels, the QX6-50 facilitates effortless cargo transfers to and from remote and hard-to-access locations.

**Ceiling altitude:** 12,000ft

**Maximum take-off weight:** 360kg

**Payload mass:** Up to 75kg

**Engine type:** Petrol

**Delivery speed:** 170km/h



# AUTONOMOUS | AIR | LOGISTICS PRODUCTS

## ADASI



FLYER



VIDEO

## AIR TRUCK

The Air Truck is a powerful logistics UAV with a 500kg payload capacity that can operate via pre-programmed mission or live operator, making it ideal for higher-risk or more dangerous missions. Suitable for military, security and civilian deployment, cargo is transported via a custom-designed Air Box that ensures rapid cargo loading and unloading.

**Engine: Gas turbine**

**MTOW (ISA): 2,500kg**

**Normal take-off weight: 2,100kg**

**Maximum payload with full tanks: 500kg**

**Main rotor diameter: 12.8m**

**Helicopter length without blades: 7.7m**

**Helicopter height: 4m**

**Maximum operating speed (VNO): 140km/h**

**Speed for maximum endurance: 90km/h**

**Service ceiling: 3,000m**

**Maximum range: (full tanks, maximum payload, 120km/h cruising speed) :360km**

**Maximum endurance: (500kg payload, 90km/h speed (ISA+35): 4h**



**AUTONOMOUS | AIR | LOGISTICS**  
**PRODUCTS**  
**ADASI**



FLYER



VIDEO

## GY-300

The ADASI GY-300 is a reliable, cost-efficient and low-maintenance heavy-duty cargo drone powerful enough to transport payloads weighing up to 300kg distances up to 400km. Its versatility is enhanced by an ability to operate in undeveloped environments, including rough unpaved terrain with short take-off and landing distances.

With a loaded endurance of four hours and unloaded endurance of six hours, the GY-300 features low maintenance and high reliability, with redundant autopilot, actuation and an engine control unit. With long-travel suspension, six-ply tires and a powerful 280hp turbo engine, this UAV makes it possible to transport critical mission payloads to remote locations inaccessible to less flexible cargo drones.

**Cruise Speed:** up to 120 km/h

**Max Speed:** up to 160 km/h

**Empty weight:** 460 kg

**MTOW:** 900 kg

**Maximum Payload:** up to 300 kg

**Endurance:** 4 hours (300 kg cargo)

6 hours (100 kg cargo)



**AUTONOMOUS | LAND | UGV**  
**PRODUCTS**  
**ADASI**



FLYER



VIDEO

## **ARMED ROBOTIC VEHICLE (ARV)**

The ARV consists of an unmanned override kit integrated to the NIMR Ajban 440 to provide an advanced, rapidly deployable, mobile and durable unmanned ground vehicle integrated with a remote-controlled weapon station (RCWS).

### **Surveillance & Reconnaissance**

**Integrated communication with other types**

**Portable and specialised remote control for UGV and RCWS**

**Manned & Unmanned - Manual, semi and auto-pilot drive**

**Communication range:** 10km LOS

**Unmanned recommended max speed:** 50km/h

**Remote control endurance:** 8 hours

**Weapon:** 12.7 mm calibre



# AUTONOMOUS | LAND | UGV PRODUCTS



## THeMIS COMBAT

THeMIS Combat UGVs provide commanders the ability to enter high-threat situations to identify and engage known or perceived threats prior to human intervention. Since the enemy cannot allow unmanned combat vehicles freedom of movement, they force the enemy to reveal their positions by engaging the robotic system.

By destroying the first patch of enemy key assets and creating a hole in the enemy's defensive or offensive posture, THeMIS Combat UGVs enhance the effectiveness of manned assets by creating momentum that human troops can leverage with fewer casualties.

**Dimensions:** 240cm x 205cm x 190cm

**Combat weight:** 1810kg\*

**Additional payload weight:** 570kg\*

**Max. speed:** 20km/h

**Ground clearance:** up to 60 cm

**Max. grade:** 31 deg / 60 %

**Fording depth:** 60cm

**Run time (hybrid, full internal tank):** up to 15h

**Run time (full load, silent mode):** up to 1, h

**Line of sight control range:** up to 10km

\* Depending on the final configuration



FLYER



## THeMIS OBSERVE

The THeMIS Observe is built for tactical reconnaissance missions. The system includes a camera for day and night operations, an acoustic gunshot detector, smoke screen protection and a ground surveillance radar. Combining those systems allows units to make multi-sensor identification on one platform and react faster on emerging targets.

The THeMIS Observe has a low acoustic signature and low radio emissions and significantly increases a tactical unit's stand-off distance from enemy units whilst considerably increasing their capability and survivability.

**Dimensions:** 247cm x 205cm x 130cm

**Weight:** 2100kg

**Max. speed:** 20km/h

**Ground clearance:** Up to 60cm

**Max. grade:** 31 deg / 60 %

**Fording depth:** 60cm

**Pull force:** 15 000 N

**Run time (hybrid, full internal tank):** Up to 15h

**Run time (full load, silent mode):** Up to 1,5h



BROCHURE



## AUTONOMOUS | LAND | UGV PRODUCTS



### THeMIS CARGO CASEVAC

THeMIS Cargo Casualty Evacuation (CASEVAC) UGVs provide two capabilities: a means to effortlessly transport supplies, equipment and extra weapons to the mission area and rapid evacuation for urgent casualties from the point of injury to higher-level medical facilities.



FLYER

**Dimensions:** 247cm x 204cm x 117cm

**UGV weight:** 1650kg

**Payload area dimensions:** 214cm x 93 (adjustable) cm

**Payload weight (rated):** 750kg

**Payload weight (max):** 1200kg

**Max. speed:** 20km/h

**Ground clearance:** 40-60cm

**Max. grade:** 31 degrees / 60 %

**Fording depth:** 60cm

**Pull force:** 15,000 N

**Run time (hybrid, full internal tank):** Up to 15h

**Run time (full load, silent mode):** Up to 1.5h



## AUTONOMOUS | LAND | UGV PRODUCTS



### T-RCV

T-RCVs are an organic part of mechanized units that can take the most dangerous positions and provide equal or overmatching firepower and tactical usage compared to traditional Infantry Fighting Vehicles. Thanks to Vegvisir's Mixed Reality Situational Awareness System T-RCV operators have a 360 degree virtual dome with EO/IR sensor fusion for both close and medium proximity vision and target engagement capabilities in any condition.

**Dimensions:** 600cm x 290cm x 220cm

**Weight with payload:** 12000kg

**Payload Weight (max):** 5,000kg

**Transmission:** Hybrid Electric Drive

**Steering:** Cross-Drive torque transfer

**Max. road speed:** 80km/h

**Max. terrain speed:** 50km/h

**Speed in reverse:** 80km/h



FLYER



### HAVOC

The HAVOC Robotic Combat Vehicle (RCV) is a cutting-edge ground combat platform enhanced with intelligent functions and designed for modern warfare. Equipped with advanced AI-driven navigation, this vehicle excels in both offensive and defensive operations across diverse terrains. Its robust 8-wheel configuration offers superior mobility, stability, and load-bearing capacity, while a suite of integrated sensors and armament ensures precision and adaptability in high-risk combat environments.

**Transmission:** All wheel hybrid electric drive

**Max. speed road:** 110km/h

**Max. speed off road:** 50km/h

**Range:** 600 km

**Ground clearance:** 0.44m

**Gradient:** 60 %

**Side slope:** 40 %

**Vertical step climb:** 0.6m

**Normal steering radius:** 10m



FLYER



## AUTONOMOUS | SEA PRODUCTS

**A2SB**  
ABU DHABI SHIP BUILDING



### 120 USV

The 120 unmanned surface vessel (USV) represents a fast, versatile unmanned platform ideally designed and configured to support a range of information related duties such as mine counter measures (MCM); anti-submarine warfare (ASW); and intelligence, surveillance, and reconnaissance (ISR).

**LOA:** 12.8m

**Beam OA:** 3.10m

**Draft:** 0.52m approx.

**Speed:** 55+ kn approx. @ Full load (Sea State 1)

**Diesel:** 2000l

**Propulsion:** Waterjet



BROCHURE



### 170 M-DETECTOR

The 170 M-Detector can be operated in manned or unmanned configuration to perform a range of surface warfare, transport, surveillance and mapping missions for naval and civilian forces. It can operate for four hours in silent electric propulsion mode or at speeds up to 40 knots in diesel mode.

**LOA:** 17.4m

**BOA:** 4.2m

**Draft:** 0.85m approx.

**Complement (Manned):** 4 crew

**Engines:** 2x 900hp diesel engines

**Propulsion:** 2x waterjets

**Electric mode range (speed 5kt):** 4 hours



BROCHURE



VIDEO





**EDGE**



**LAND  
SYSTEMS**

**NIMR**

**AL JASOOR**

# LAND SYSTEMS

Enhancing frontline support with state-of-the-art light-, medium- and heavy-armoured vehicles designed for the harshest environments and ready to meet diverse mission requirements, from reconnaissance and patrol to transporting personnel or the wounded.

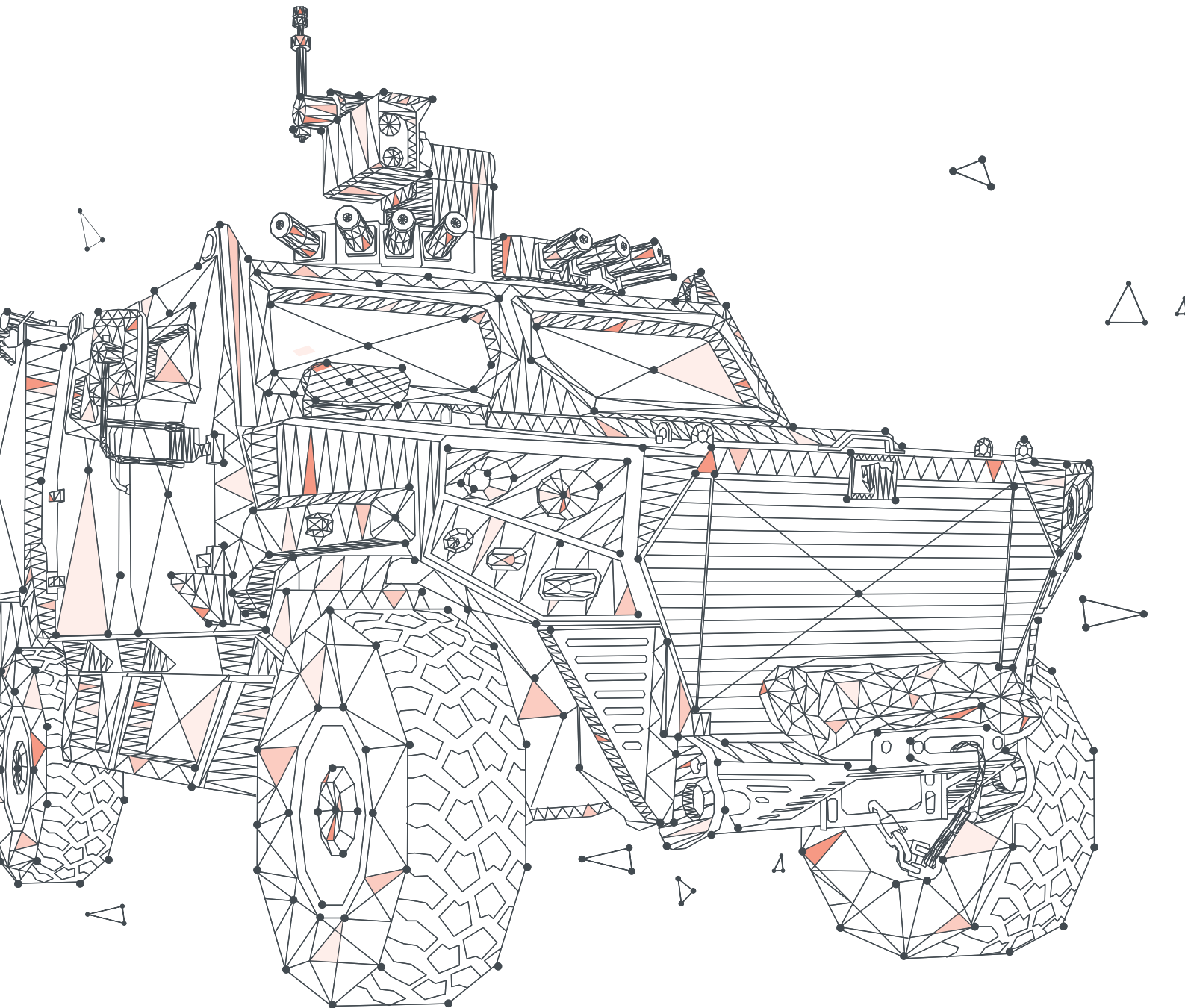



## LAND SYSTEMS - VEHICLES PRODUCTS

# AL JASOOR



BROCHURE



VIDEO

### RABDAN 8x8 INFANTRY FIGHTING VEHICLE

Rabdan is a next-generation amphibious, modular, multi-wheeled armoured vehicle with superior tactical and technical characteristics. It is offered with AL JASOOR integrated logistical support, today and for years to come.

**Engine:** 6 Cylinders, Turbo-charged, Inter-cooled, 600hp, Diesel

**Transmission:** Automatic, 6 +1 gears

**GVW:** up to 30,000kg

**Max. speed:** 105km/h

**Max. amphibious speed:** 9km/h

**Crew capacity:** Up to 12 personnel



LAND SYSTEMS - VEHICLES

PRODUCTS

AL JASOOR



BROCHURE



VIDEO

## RABDAN 6x6 INFANTRY FIGHTING VEHICLE

RABDAN 6X6 is a new generation, amphibious, modular multi-wheel armoured vehicle with superior tactical and technical characteristics.

**Engine:** Turbo charged diesel engine 450hp

**Transmission:** Automatic

**GVW:** Up to 22500kg

**Max. speed:** 105km/h

**Max. amphibious speed:** >8 km/h

**Crew Capacity:** Up to 10, including driver and commander



## LAND SYSTEMS - VEHICLES PRODUCTS

# AL JASOOR



BROCHURE



VIDEO

### RABDAN RECOVERY

The Recovery Vehicle has a powerful 720 HP engine and is fully prepared to keep up with the armoured formations, manoeuvre in harsh terrains and intervene quickly and swiftly to perform its recovery mission on armoured military vehicle.

**Gross Vehicle Weight:** 40000kg

**Growth Potential:** 43500kg

**Seating Capacity:** Driver, commander, and 2 technicians

**Length:** (with recovery equipment) 10500mm

**Width (with mirror folded):** 3350mm

**Height (with recovery equipment):** 4050mm



## LAND SYSTEMS - VEHICLES PRODUCTS

# AL JASOOR



BROCHURE

### RABDAN 8x8 AMBULANCE VEHICLE

Having superior off-road mobility, amphibious capability and high protection capabilities, the RABDAN Ambulance Vehicle is uniquely configured to provide medical support at the far frontlines of the battlefields.

**Gross Vehicle Weight:** Up to 30.000kg

**Seating Capacity:** 1 driver, 1 commander, 2 medics, 2 stretchered patients, and 3 sitting patients or, 1 driver, 1 commander, 2 medics, 3 stretchered patients

**Length:** 8.45m

**Width:** 3.25m

**Height:** 2.72m (over hull)



## LAND SYSTEMS - VEHICLES PRODUCTS NIMR



BROCHURE

### AJBAN MK2 CLASS

The AJBAN MK2 442A 432AU, 452A are 4x4 ballistic and blast protected light tactical patrol vehicle for a crew of five. This multi-role capacity vehicle is constructed with a V-hull unit structure for effective mine-blast protection.

**Configuration:** 4x4

**GVW:** 13,500kg

**Max speed:** 110 km/h

**Wheelbase:** 3,500mm

**Cruising range:** 700km @ 100km/h

**Ground clearance:** 420mm



BROCHURE

### HAFEET MK2 CLASS

The 6x6 HAFEET MK2 632A and 63AU vehicle provides a multi-purpose platform for military requirements such as armoured personnel carrier, artillery application, ambulance or observation vehicle.

**Configuration:** 6x6

**GVW:** 17,500kg

**Wheelbase:** 3,170mm between 1st and 2nd axle  
1,300 mm between 2nd and 3rd axle

**Cruising range:** 700km @ 100km/h

**Ground clearance:** 420mm





## LAND SYSTEMS - VEHICLES PRODUCTS NIMR



FLYER



VIDEO

### LRSOV

AJBAN LRSOV (Long Range Special Operations Vehicle) is an open top 4x4 vehicle especially suited to long range reconnaissance missions typically undertaken by Special Forces.

The vehicle has the following traits which places it as a leader in this category; Light and powerful, capable of accessing all terrains in addition to being helicopter underslung transportable. A Special feature of the vehicle is the open cab, which allows for the fitment of a variety of weapons and mission systems. The vehicle generic architecture will allow fitment of user supplied communications equipment. The vehicle is highly mobile with a high power to weight ratio, a stiff chassis and advanced independent suspension.

**Engine power:** 296 hp@ 2500 rpm

**Engine torque:** 1,100 Nm @ 1500 rpm

**Transmission:** 6-speed automatic

**Cruising range:** 700 km @ 100 kmph on highways

**Gross weight:** 9,000kg

**Payload:** 2,500kg

**Maximum crew:** 4



LAND SYSTEMS - VEHICLES

PRODUCTS

NIMR



BROCHURE



VIDEO

## JAIS CLASS

The JAIS MK2 offers enhanced protection for critical systems and improved mobility within the same overall weight class. Featuring a larger payload, internal crew capacity, and expanded external storage, its design prioritises ergonomics. It also boasts a reduced thermal signature and Electromagnetic Interference (EMI) compliance, elevating overall efficiency.

**Engine power:** 450hp/600hp

**Engine torque:** 1,850Nm / 1,900Nm

**Maximum speed:** 100km/h

**Cruising range:** 700km



**EDGE**



# NAVAL SYSTEMS

**ADSB**  
ABU DHABI SHIP BUILDING

# NAVAL SYSTEMS

Delivering end-to-end maritime solutions and systems for military and civilian missions through design, engineering, new build, maintenance and related services. Meeting today's requirements, platforms range from Combattante and patrol vessels, floating landing pads and tugboats to houseboats and training cabins.

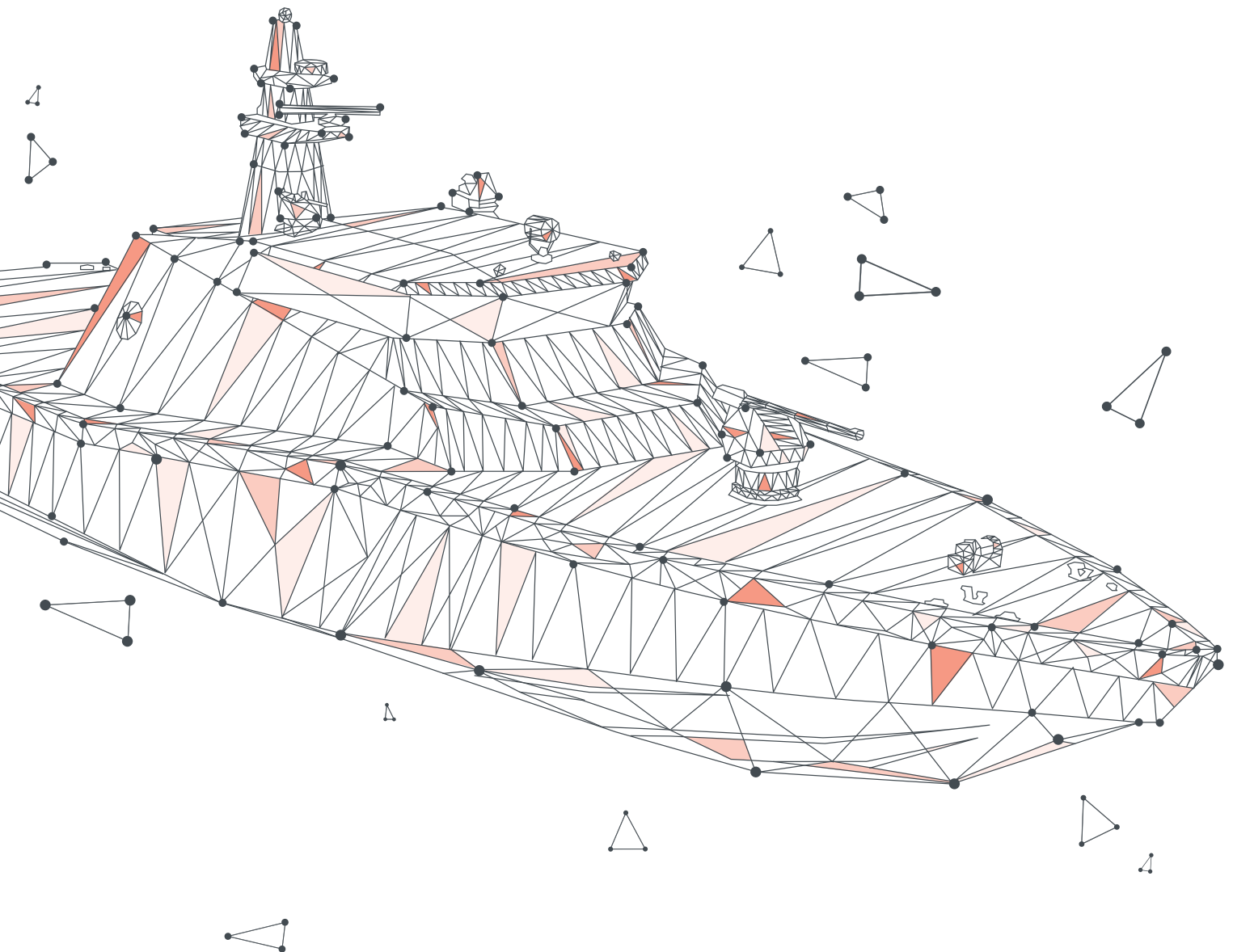



NAVAL  
PRODUCTS

**AJSB**  
ABU DHABI SHIP BUILDING



## 160 SEA PAD

The 16-metre SEA PAD offers exceptional support to offshore intelligence, surveillance and reconnaissance (ISR) operations by providing a landing pad for UAVs with a rotor diameter of up to 3.8 metres and by serving as an ideal platform for the launch and recovery of sonars.

**LOA:** 16m

**Beam oa:** 3.89m

**Draft:** 0.87m approx.

**Speed:** 30kn approx. (With 5t load)

**Complement:** up to 25 crew

**Diesel:** 2 x 1000L

**Water:** 100L

**Propulsion:** 2 x waterjets



BROCHURE



VIDEO



## FA-400 OFFSHORE PATROL VESSEL

With robust seakeeping characteristic, the 42-metre FA-400 offshore patrol vessel is built for speed and equipped to perform a range of territorial and coastal offshore duties, including providing support to military operations, search and rescue, area surveillance, and patrol.

**LOA:** 45m

**Beam moulded:** 8.0m

**Depth at midship:** 4.6m

**Draught:** 2.4m approx.

**Speed @ half LOA:** 30+ knots max

**Speed @ full load:** 26 knots

**Cruising speed:** 14 knots

**Range at 14 knots:** 1500 nautical miles

**Complement:** 20 persons

**Endurance:** 5-6 days

**Propulsion system:** 4x1939 kw MTU 16V 2000 M96L



FLYER



NAVAL  
PRODUCTS

**ADSB**  
ABU DHABI SHIP BUILDING



## 160 SEA KEEPER

The 16-metre "Sea Keeper" Fast Landing Craft benefits from a proven design and ADSB construction excellence to offer a world-class rapid amphibious supply vessel for transport of vehicles and equipment.

**LOA:** 16.45m

**BOA:** 3.89m

**Draft:** 0.7m approx.

**Range:** 325 nautical miles

**Propulsion:** 2x waterjet



FLYER



## 160 SEA TROOPER

The 16.45-metre SEA TROOPER features a landing-craft layout with bridge aft and cargo area forward with a bow ramp, providing an ideal platform for cargo, troop and vehicle transport missions.

**LOA:** 16.45m

**Beam OA:** 3.89m

**Draft:** 0.87m approx.

**Speed:** 30kn approx. (with 5T load)

**Complement:** Up to 25 crew

**Diesel:** 2 x 1,000 litres

**Water:** 100 litres

**Propulsion:** 2 x waterjets



BROCHURE



VIDEO



NAVAL  
PRODUCTS

**ADSB**  
ABU DHABI SHIP BUILDING



## 120 FIP

The 120 Fast In-shore Platform (FIP) provides key tactical capabilities to naval, security and coast guard operations. The 120 FIP is a superior patrol boat, that delivers exceptional capabilities to maritime forces.

**LOA:** 12.8m

**Beam OA:** 3.1m

**Draft:** 0.52m approx.

**Load displacement:** 5.5T approx

**Speed:** 60+ kn approx. @ full load (Sea State 1)

**Complement:** 6 crew

**Petrol:** 1,000 litres

**Water:** 88 litres

**Propulsion:** 3 x 400hp outboard engines



BROCHURE



## BR71 MK II COMBATTANTE

The ADSB 71-metre MK II Combattante vessel represents a powerful and exciting evolution and upgrade to the CMN (Construction Mécaniques de Normandie) sea-proven Baynunah class. Designed by CMN for littoral warfare defence operations against air and surface threats and a range of surveillance missions, the platform is fast, powerful, compact and modular.

**LOA:** 70.30m

**Length between perpendiculars:** 62.30m

**Draft:** 3m approx.

**Full load displacement:** approx. 895t

**Max speed (half load):** 30kts

**Speed cruising:** 12 kts

**Crew:** 50

**Range (12 knots):** 2500nm

**Propulsion:** 4x diesel engines located in two engine rooms (MTU); 4x Waterjets (Kongsberg);



BROCHURE





NAVAL  
PRODUCTS

**AOSB**  
ABU DHABI SHIP BUILDING



### 60m FALAJ 3

Capable of operating in both littoral and blue waters, the 60-metre FALAJ 3 naval patrol vessel is designed and equipped suitably not only for advanced Naval duties but also for tackling the present day challenges of asymmetric warfare. Featuring a state-of-the-art combat management system, sensors and weapons, this platform can undertake warfare in three dimensions – Air, Surface and Sub-surface.

**LOA:** 62.7m

**Breadth (moulded):** 9.5m

**Depth:** 4.45m

**Draft (moulded):** 2.6m

**Max draft at prop.:** 3.4m

**Full load displacement:** 680t approx.

**Max speed:** 25 kn

**Range at 16 knots:** 2000nm

**Complement:** 39 persons



BROCHURE



VIDEO



### 160 ITEP

The 16-metre inshore tactical and engagement platform (ITEP) delivers power and performance for high-speed pursuit, fast interception and a wide range of general patrol missions.

**LOA:** 16m

**BOA:** 4.10m

**Draft:** 0.85m approx.

**Speed:** 45+ kn approx. @ full load (Sea State 1)

**Propulsion:** 2 x waterjets/2 x 1,000hp inboard diesel engines



BROCHURE



VIDEO



NAVAL | USV

PRODUCTS

**ADSB**  
ABU DHABI SHIP BUILDING



## 28M ASD TUGBOAT

The ADSB 28M ASD Tugboat provides towage, tailback towing, and hose handling services for ADNOC Petroleum Ports jetties and SPMs. Offering high manoeuvrability at slow speeds, a tight turning radius, operational in sea swells up to 6 feet and 24/7 operation, the tugboat also can assist with firefighting and search and rescue.

**LOA:** 28 m

**Breadth (moulded):** 11.8m

**Depth (moulded):** 4.48m

**Draft (ABL):** 3.4m

**Installed power:** 2 x 1,900kW

**Bollard pull:** 60 tonnes



FLYER



## 24M HOUSE BOAT

**Length over all:** 20.00m

**Length b.P:** 18.80 M

**Beam overall:** 07.20 M

**Draft (full load):** 00.85 M approx.

**Speed:** 10knots approx@ full load.

**Cruising range:** 350+ nautical miles



BROCHURE



**EDGE**

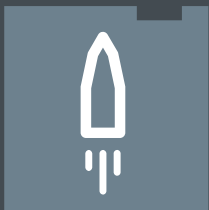

**PRECISION  
GUIDED  
WEAPONS**

**ADASI**

**AL TARIQ**

**HALCON**

**SIATT**

# PRECISION GUIDED WEAPONS

Producing smart, modular munitions with multiple-option, precision-targeting capabilities in both short- and long-range format and multiple warhead options, as well as launcher units and carrying racks.

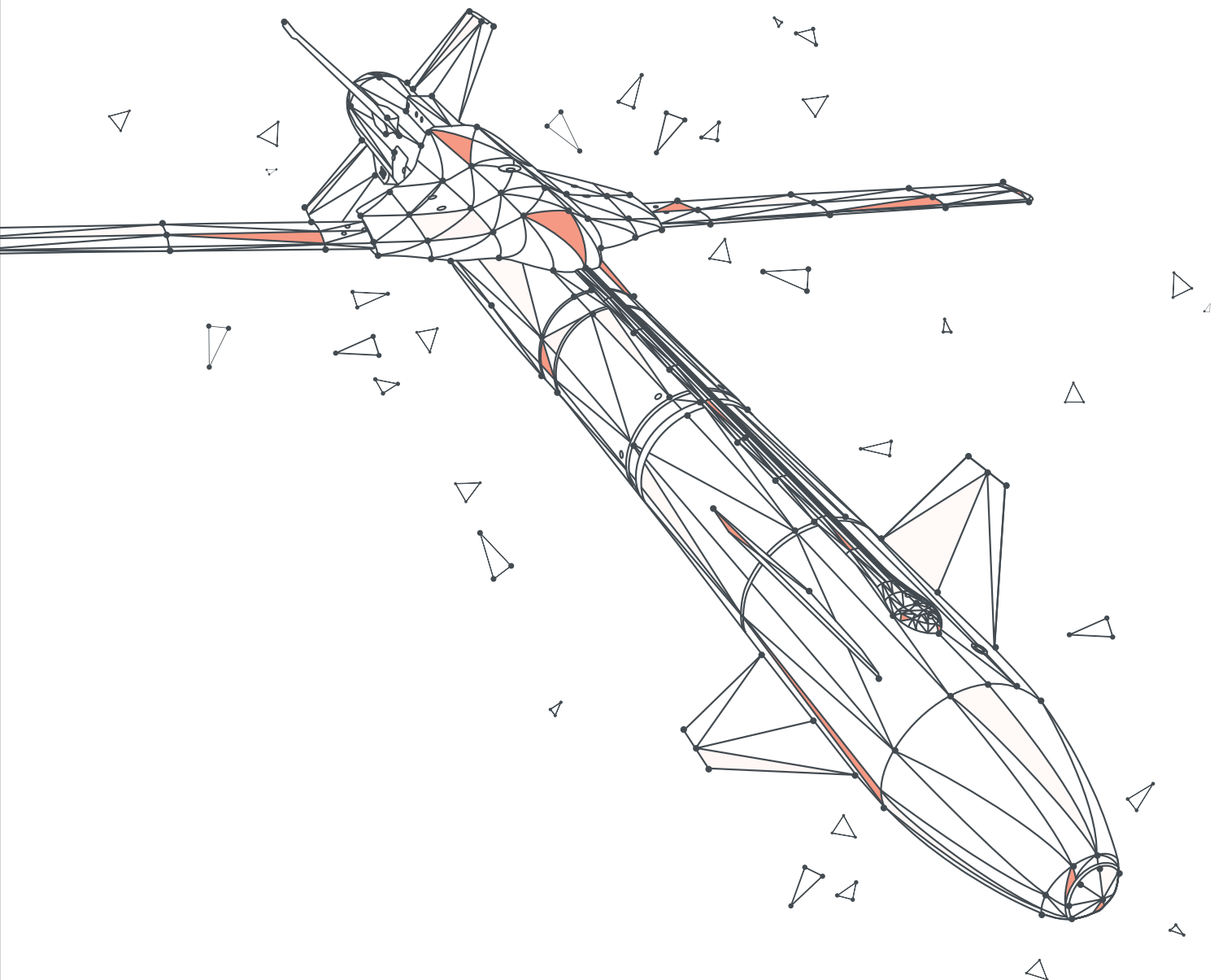

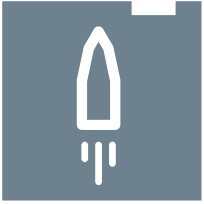

## MISSILES & WEAPONS | AIRBORNE PRODUCTS

# AL TARIQ



BROCHURE



VIDEO

### AL TARIQ LONG RANGE PRECISION GUIDED MUNITIONS

- Al Tariq is a strap-on bomb kit system, used on the Mk-80 family of standard aircraft bombs
- The weapon system provides the user with all-weather, day and night operational capabilities, utilizing
  - GNSS guidance
- Increased targeting accuracy through:
  - Semi-active laser (SAL) seeker
  - Imaging infrared (IIR) seeker
- Hybrid GPS/INS navigation
- Accuracy (excluding Target Location Errors):
  - 10m CEP GPS/GNSS-INS only (C/A code)
  - 2m with IIR seeker
  - 3m with SAL seeker
- Programmable attack angle in azimuth and elevation
- Standard 14" inch bomb rack interface to aircraft
- Fits Mk-80 family of standard NATO warheads
- Long range up to 120km
- Modular with more than 20 configurations based on required missions
- Provide anti-jamming solutions
- Height of Burst sensor integrated

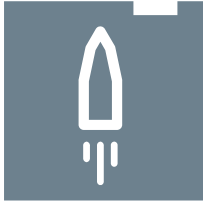

## MISSILES & WEAPONS | AIRBORNE PRODUCTS

# AL TARIQ



### AL TARIQ LR – LONG RANGE

**Stand-off range:** up to 120km

**Warhead:** Mk81, Mk82, and Mk83

**Guidance:** GNSS/INS with IIR or SAL.

**Wings installed**



### S – STANDARD RANGE

**Stand-off range:** up to 45km

**Warhead:** Mk81, Mk82, and Mk83

**Guidance:** GNSS/INS with IIR or SAL

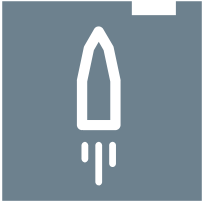

## MUNITIONS & AMMUNITIONS | AMMUNITION PRODUCTS

**ADVANCED**  
CONCEPTS

### NASEF 10

**Cruise Speed:** Up to 0.3 Mach (350 km/h)

**Ceiling Altitude:** 18,000 ft

**Propulsion system:** Jet Engine (32Kg thrust)

**Weight:** 35 kg

**Communication range:** 100 km

**Operation range:** 150 km

**Wingspan:** 1.1m

**Length:** 1.4 m



BROCHURE



### NASEF 20

**Cruise Speed:** Up to 0.3 Mach (350 km/h)

**Ceiling Altitude:** 27,000 ft

**Propulsion system:** Jet engine (45 kg thrust)

**Weight:** 70 kg

**Communication range:** 100 km

**Operation range:** 260 km

**Wingspan:** 1.6m

**Length:** 2.5m



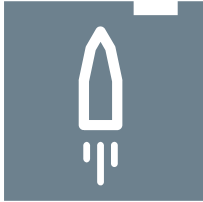

## MUNITIONS & AMMUNITIONS | AMMUNITION PRODUCTS

# HALCON



FLYER

### G-70

**Length:** 750 mm

**Diameter:** 70 mm

**Range:** 700m (with self designation); 4,000m (with remote designation by drone)

**Mass:** 4kg

**Max speed:** 300 m/s



FLYER

### G-120

**Length:** 1,000 mm

**Diameter:** 120 mm

**Accuracy:** 0.5 m CEP

**Minimum range:** 1,000 m

**Maximum range:** 8,000 m

**Mass:** 14 kg

**Launch envelope:** Speed: 40 kts to 150 kts  
Altitude: 1,000 ft to 30,000 ft

**Flight envelope:** Mach number: M 0.3 to M 1.2  
Altitude: 0 to 40,000 ft

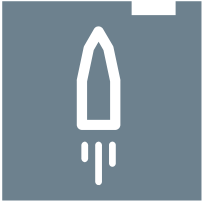

## MISSILES & WEAPONS | AIRBORNE PRODUCTS

# HALCON



### THUNDER P-31

The Thunder is a family of cost-effective, short-range, guidance kit that can be fitted to the MK-82 (P-32) and the MK-81 (P-31) general purpose aerial munitions.

**Accuracy:** 3m CEP GAINS + SAL seeker /10m CEP GAINS only

**Range:** 18km-20km



### THUNDER P-32

The Thunder is a family of cost-effective, short-range, guidance kit that can be fitted to the MK-82 (P-32) and the MK-81 (P-31) general purpose aerial munitions.

**Accuracy:** 3m CEP GAINS + SAL seeker/10m CEP GAINS only

**Range:** 18km-20km



## MISSILES & WEAPONS | AIRBORNE PRODUCTS

# HALCON



### THUNDER P-4

The Thunder-4, another member of the Thunder family, is a cost-effective, short-range, guidance kit that can be fitted to the MK-84 general purpose aerial munition.

**Accuracy:** 3m CEP GAINS + SAL seeker, 10m CEP GAINS only

**Range:** 16km-18km



### DESERT STING (DS-16)

Desert Sting utilises inertial guidance augmented by global navigation satellite system (GNSS) information (GAINS). A semi-active laser (SAL) seeker configuration further improves accuracy performance against designated targets.

**Gross weight:** 23kg

**Warhead:** Pre-fragmented 12kg

**Accuracy:** 3m CEP GAINS + SAL seeker/10m CEP GAINS only

**Remo range:** >15km



FLYER



FLYER

## DESERT STING (DS-25)

The Desert Sting is a family of light weight, air platform released, precision guided glide weapons (GGW).

**Gross weight:** 47kg

**Warhead:** Pre-fragmented 24kg

**Accuracy:** 3m CEP GAINS + SAL seeker/10m CEP GAINS only

**Max range:** >24km



FLYER

## DESERT STING DS-16 DUAL RACK

The Dual Rack (2 weapons) caters for both piloted and remotely piloted platforms.

**Length:** 1,150mm

**Width:** 440mm

**Height:** 200mm

**Mass:** 28kg

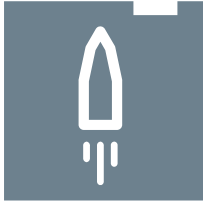

FLYER

### DESERT STING DS-16 QUAD RACK

The Quad Rack (4 weapons) caters for various platforms.

**Length:** 1,880mm

**Width:** 435mm

**Height:** 200mm

**Mass:** 45kg



FLYER

### DESERT STING DS-25 DUAL RACK

The Dual Rack (2 weapons) caters for both piloted and remotely piloted platforms.

**Length:** 1,680mm

**Width:** 485mm

**Height:** 270mm

**Mass:** 36kg

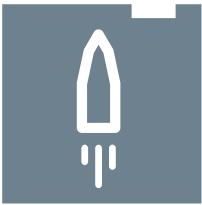

# MISSILES & WEAPONS | AIR DEFENCE PRODUCTS

## HALCON



### SKYKNIGHT

The Skynex SkyKnight air defence system provides rapidly deployable, comprehensive inner-layer protection against a wide variety of asymmetric and conventional threats, including rockets, artillery shells, mortars (RAM), ballistic bombs and stand-off weapons.



FLYER

#### MISSILES (INTERCEPT RANGE)

**RAM threats:** 4,000m

**PGM, CM:** 6,000m

**Rotary wing, CM and UAV:** 10,000m

**Fixed wing:** 10,000m / 8,000m (maneuvering)

**GUNS** (employing the applicable AHEAD ammunition version)

**FW/RW:** 4,000m

**Mortars, small UAVs:** 1,500m

#### RATE OF FIRE

Up to 4 x RG Mk3 guns: 1,000 rounds/minute per gun

Up to 20 x missiles simultaneously per MLU

Up to 80 x missiles in flight at the same time



VIDEO

#### MISSILE PARAMETERS

**Length:** 2.2m

**Diameter:** 115mm

**Wing span:** 300mm

**Mass:** 36kg



### SKYKNIGHT MISSILE LAUNCHER UNITS

**Mass (empty):** 4500kg

**Total mass:** 8,800kg

**Number of missiles:** 60

**Rate of fire:** 5/sec

**Dimension:** 20ft ISO container



FLYER



VIDEO

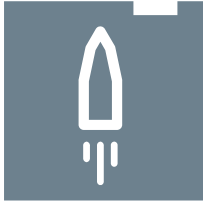

## MISSILES & WEAPONS | AIRBORNE PRODUCTS

# ADASI

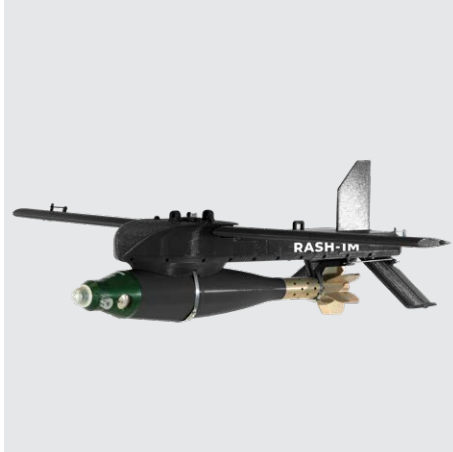

### RASH - 1 M

The RASH precision-guided munition is a modern glider system featuring advanced automation and communication technology. This system is modular, low-cost, and highly configurable to fit onto most existing aircraft system.

**Weight with Munition:** 2.5 kg

**Maximum Altitude:** 15,000 ft

**Maximum Launch Range:** 9 km

**Fuse Type:** Impact

**Guidance:** GPS INS



FLYER



### RASH - 2 M

The RASH-2M converts a standard mortar into a low-cost, high-precision guided munition system capable of swiftly engaging unexpected small- to medium-sized threats.

**Weight with Munition:** 14.5 kg

**Maximum Altitude:** 25,000 ft

**Maximum Launch Range:** 24 km

**Fuse Type:** Impact

**Guidance:** GPS INS



FLYER

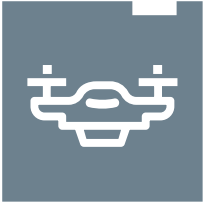

# MISSILES & WEAPONS | AIRBORNE PRODUCTS ADASI



## RASH - 2 H

RASH-2H is a low-cost, high-precision guided munition system capable of swiftly engaging unexpected small to medium-sized threats. The system is ideal for patrol missions, border security, and accurately eliminating high-value threats.

- Weight with Munition:** 15 kg
- Maximum Altitude:** 25,000 ft
- Maximum Launch Range:** 23 km
- Fuse Type:** Both Impact and Proximity
- Guidance:** GPS INS



FLYER



## RASH - 3 H

With its cost-effective pricing, the RASH-3 provides rapid engagement and neutralization of small-to medium-sized threats via a high-precision guided munition system.

- Weight with Munition:** 33 kg
- Maximum Altitude:** 25,000 ft
- Maximum Launch Range:** 23 km
- Fuse Type:** Both Impact and Proximity
- Guidance:** GPS INS



FLYER



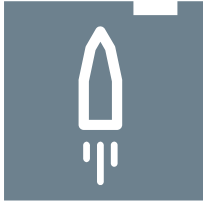

## MISSILES & WEAPONS | AIRBORNE PRODUCTS

# HALCON



FLYER

### SABER

SABER is a strategic, high precision air-to-ground cruise missile system providing deep strike mission capabilities of heavily defended high value targets.

**Payload:** 350 kg

**Max altitude:** 20,000 feet

**Cruising speed:** 0.8mach

**Max range:** 290km



**MISSILES & WEAPONS | SURFACE**  
**PRODUCTS**  
**SIATT**



FLYER

### **MANSUP-ER**

**Range:** 200km

**Speed:** 954km/h

**Payload:** 150kg warhead

- Sea-state adapted sea skimming
- On-board altimeter
- Flexible 3D Waypoints
- All-weather capability
- Operational Flexibility: unlimited overland flight, terminal manoeuvres, land attack capability, simultaneous (time-on-target) missiles attack

### **MANSUP**

**Range:** 70 kms

**Speed:** 700 km/h

**Payload:** 150 kg Warhead

- Sea-state adapted sea skimming
- On-board altimeter
- All-weather capability
- Operational Flexibility: unlimited overland flight, terminal manoeuvres, land attack capability, simultaneous (time-on-target) missiles attack



**EDGE**



# MUNITIONS & AMMUNITION

**LAHAB**  
DEFENCE SYSTEMS

**ADVANCED**  
CONCEPTS

**HALCON**

**CONDOR**

**CARACAL**  
LIGHT AMMUNITION

# MUNITIONS & AMMUNITION

Helping infantry and air forces hit the mark with munitions and ammunition for a wide range of large-calibre weapons, such as grenade launches and mortar launchers, as well as gravity bombs and bomb kits.

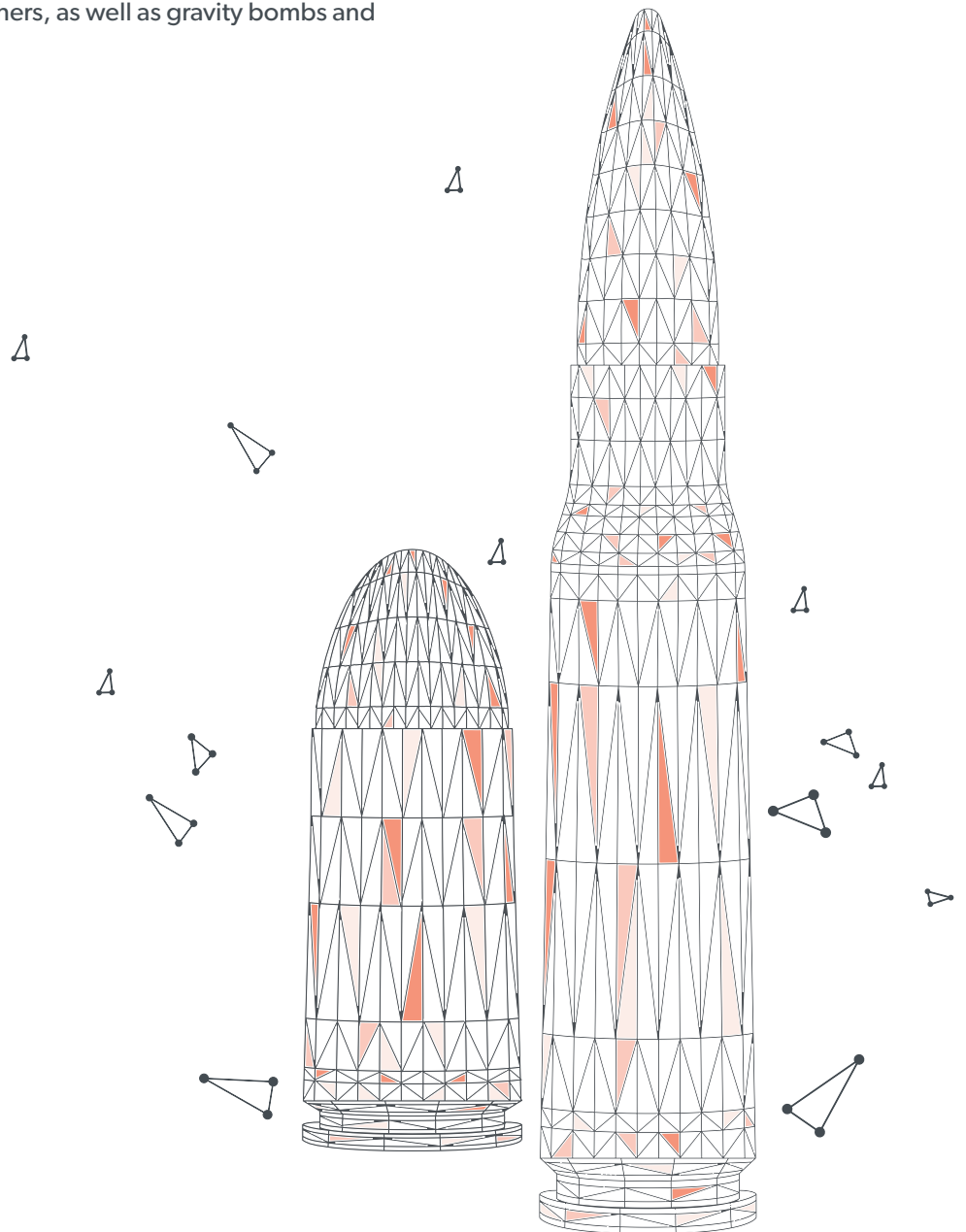

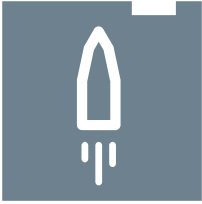

## MUNITIONS & AMMUNITIONS | AMMUNITION PRODUCTS

**LAHAB**  
DEFENCE SYSTEMS  
لأنظمة الدفاعية



BROCHURE



CORPORATE VIDEO

### GRENADES

- 40 x 53mm HEDP AE1501A1
- 40mm x 46 LV HEDP



### MORTARS

- 60mm HE Mortars
- 81mm HE Mortars
- 120mm HE Mortars



## MUNITIONS & AMMUNITIONS | AMMUNITION PRODUCTS

**LAHAB**  
DEFENCE SYSTEMS  
للأنظمة الدفاعية



BROCHURE



CORPORATE VIDEO

### ARTILLERY AMMUNITION

- 155mm ERFB HE BT
- TR 107mm
- TR 122mm



### AIRCRAFT BOMBS

- MK-81
- MK-82
- MK-83
- MK-84

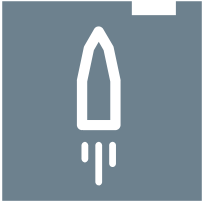

## MUNITIONS & AMMUNITIONS | AMMUNITION PRODUCTS

# HALCON



FLYER

### MK82 BOMB WITH KIT

**Length:** 2117mm length of warhead with tail kit and 1538.5mm length without tail kit

**Mass with Explosive:** 210kg +/- 10kg

**Mass without Explosive:** 120.5kg +/- 7.5kg

**Warhead Diameter:** 288.41mm



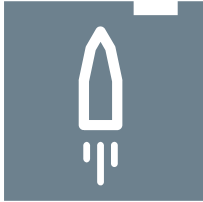

**SMALL ARMS | AMMUNITION**  
**PRODUCTS - SMALL CALIBRE**  
**CARACAL**  
LIGHT AMMUNITION



BROCHURE

At CARACAL LIGHT AMMUNITION, we offer highly efficient, high-volume production capability in the UAE, supported by world-leading components and complemented by the ability to handle multiple customisation requests.

Quality is built in to every stage of our product development process, with regular testing and inspection throughout the innovation cycle. From our state-of-the-art ballistics test area and chemical laboratory, to our materials testing laboratory and proof ranges, we have the resources to innovate and manufacture small arms products with the highest precision and most consistent reliability

- 9 x 19mm Blank (MIL-SPEC Standards)
- 9 x 19mm Ball equivalent to (M882) (NATO and MIL-SPEG Standards)
- 5.56 x 45mm Blank (M200) (MIL-SPEC Standards)
- 5.56 x 45mm Ball (M855) (NATO and MIL-SPEC Standards)
- .223 (55 Grains) (MIL-SPEC Standards)
- 5.56 x 45mm Tracer (M856) (NATO and MIL-SPEC Standards)
- 7.62 x 51mm Blank (M82) (MIL-SPEC Standards)
- 7.62 x 51mm Ball (M80) (NATO and MIL-SPEC Standards)
- 7.62 x 51mm Tracer (M62) (NATO and MIL-SPEC Standards)
- 12.7 x 99mm /.50 BMG Ball (M33) (NATO and MIL-SPEC Standards)
- 12.7 x 99mm /.50 BMG Tracer (M17) (NATO and MIL-SPEC Standards)
- 12.7 x 99mm /.50 BMG API (M8) (NATO and MIL-SPEC Standards)
- 12.7 x 99mm /.50 BMG API-T (M20) (NATO and MIL-SPEC Standards)

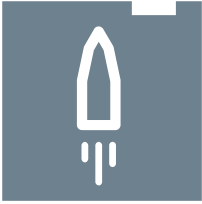

# MUNITIONS & AMMUNITIONS | NON-LETHAL AMMUNITION PRODUCTS

## CONDOR



BROCHURE

### GRENADES

Condor produces specialised grenades for both indoor and outdoor use. Both types use a dual-stage system on rubber-bodied grenades that ejects the trigger before the main charge explodes. The grenades incorporate multiple rubber spheres, with different products to control crowds in different settings and situations. Some grenades feature powerful stun and impact charges; others produce dense smoke. Both types also can incorporate lachrymatory and pepper components.



BROCHURE

### PYROTECHNICS

Due to their high-deterrent power, Condor's controlled-impact munitions, including rubber bullets, provide an effective, last-step non-lethal alternative to conventional ammunition in crowd-control settings. Condor rubber bullets for use against individuals and groups are available in 12 mm, 37/38 mm and 40 mm calibre.

Condor's lachrymatory, pepper and smoke ammunition has been developed for launch over obstacles, such as walls and barricades, to disperse disruptive crowds. Ammunition is available in 12 mm, 37/38 mm, 37/40 mm and 40 mm calibre. Condor also has developed ammunition for use in 40 mm launchers to provide forces with greater flexibility, and higher accuracy and effectiveness.

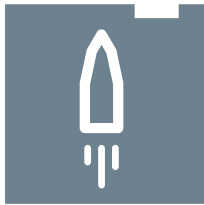

## MUNITIONS & AMMUNITIONS | NON-LETHAL AMMUNITION PRODUCTS

# CONDOR



BROCHURE

### AMMUNITION

Due to their high-deterrent power, Condor's controlled-impact munitions, including rubber bullets, provide an effective, last-step non-lethal alternative to conventional ammunition in crowd-control settings. Condor rubber bullets for use against individuals and groups are available in 12 mm, 37/38 mm and 40 mm calibre.

Condor's lachrymatory, pepper and smoke ammunition has been developed for launch over obstacles, such as walls and barricades, to disperse disruptive crowds. Ammunition is available in 12 mm, 37/38 mm, 37/40 mm and 40 mm calibre. Condor also has developed ammunition for use in 40 mm launchers to provide forces with greater flexibility, and higher accuracy and effectiveness.

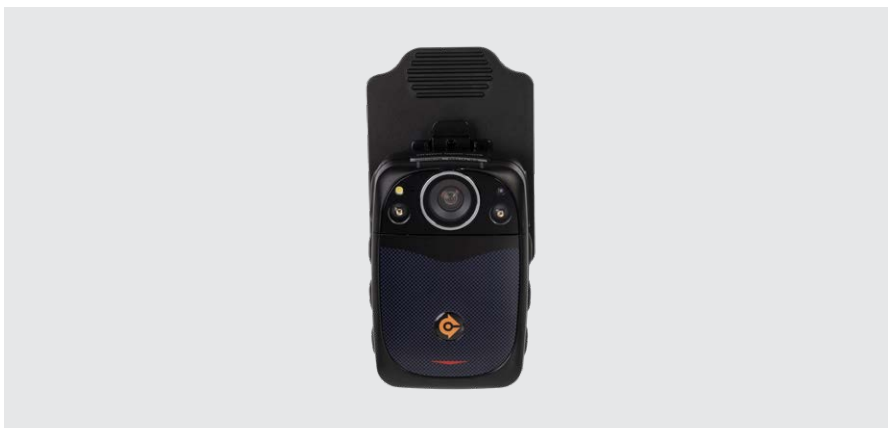

BROCHURE

### BODYCAM

The Condor Cop-Eye is an enhanced bodycam that integrates advanced facial recognition and OCR (optical character recognition) technologies for rapid identification of persons of interest – a valuable tool when operating in complex environments or at large events.



# MUNITIONS & AMMUNITIONS | NON-LETHAL AMMUNITION PRODUCTS

## CONDOR



BROCHURE

### LAUNCHERS

Condor launchers have been developed to fire the entire range of 37/38 mm, 37/40 mm and 40 mm ammunition. This ensures security forces and others involved in crowd control, law enforcement or security operations have the flexibility to deploy the full range of munitions, as required by each unique incident requirement.



BROCHURE

### SPRAYS

Condor pepper and tear sprayers are designed for self-defense, crowd control and crime fighting. The action of the agents in Condor products is immediate, causing the involuntary closing of the eyes and an intense sensation of burning in the eyes, mouth, nose and throat.

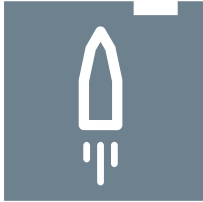

## MUNITIONS & AMMUNITIONS | NON-LETHAL AMMUNITION PRODUCTS

# CONDOR



BROCHURE

### SPARK

Condor's Spark is an incapacitating conducted electrical device (CED) that sends electrical pulses at distance from two probes connected to an isolated copper wire. Featuring safe ejection, SPARK acts directly on the neuromuscular system, causing strong muscular contractions, allowing law enforcement to temporarily incapacitate a suspect.



BROCHURE

### DRONES

The Condor Drop is a high-precision, remote airdrop delivery system for non-lethal technologies. It provides a safe standoff distance for law enforcement and also increases safety for targets.

**EDGE**



**SMALL ARMS**

**CARACAL**

# S M A L L A R M S

Designing, testing and manufacturing high-performance small arms tailored to the requirements of law enforcement, security organisations, and military forces, as well as for the civilian sporting enthusiast.

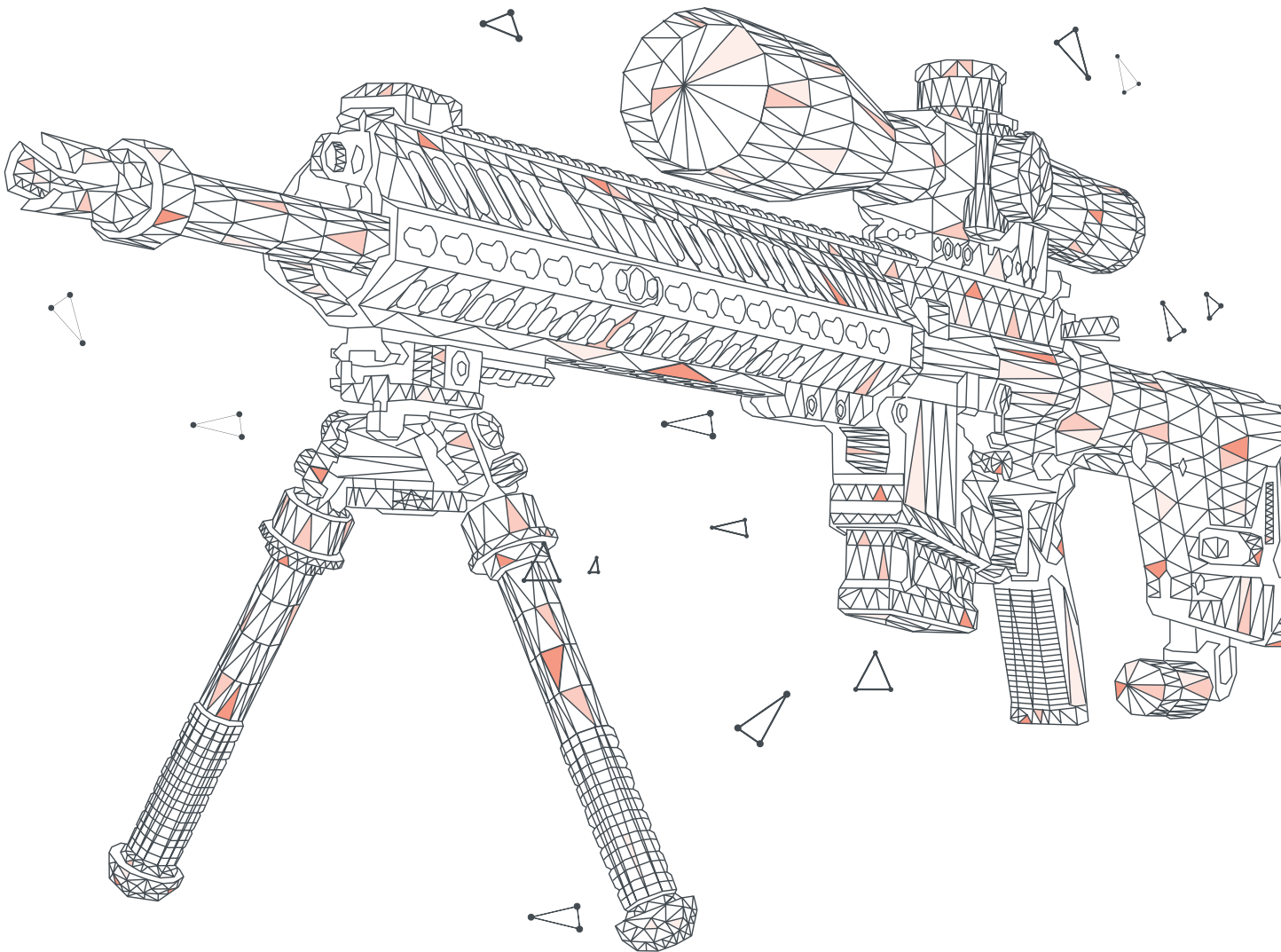



## SMALL ARMS | INFANTRY PRODUCTS

# CARACAL



FLYER

### ENHANCED F

The CARACAL Enhanced F pistol is the elite choice in law enforcement sidearms. Chambered in 9mm, it is ideal for self-defence, concealed carry, and combat, with a simplified design and polymer construction that ensures affordability.

**Calibre:** 9 x 19mm

**Operating principle:** Short Recoil, Locked-Breech

**Modes of fire:** Semi-auto

**Trigger type:** Short double action

**Magazine:** 18 rounds

**Barrel length:** 105mm

**Weight w/o magazine:** 670g

**Grip frame:** Black, polymer storage compartment



FLYER

### CARACAL F GEN II

The CARACAL F Gen II semi-automatic pistol reflects exceptional firearm innovation. Its integrated solid slide, refined trigger, and MIL-SPEC picatinny rail provide complete operator confidence.

**Calibre:** 9 x 19mm

**Operating principle:** Short Recoil, Locked-Breech

**Modes of fire:** Semi-auto/Manual safety optional

**Trigger type:** Short double action

**Magazine:** 18 rounds

**Barrel length:** 105mm

**Weight w/o magazine:** 690g

**Grip frame:** Black, polymer storage compartment



VIDEO





SMALL ARMS | INFANTRY  
PRODUCTS  
**CARACAL**



FLYER

### CMP9 SMG

The CMP9 is a modern and modular submachine gun chambered in 9x19mm, serving diverse missions with barrel options of 5.5" or 9". An ideal choice for law enforcement and special forces, the firearm is designed for compact close-range operations and excels in urban combat and precision engagements. Its discreet CMP9 Short variant supports concealed carry, ensuring constant preparedness.

**Calibre:** 9 x 19mm

**Operating principle:** Advanced blowback system

**Modes of fire:** Safe -semi-automatic - fully automatic

**Trigger type:** MIL-SPEC

**Magazine:** 30 rounds

**Buttstock:** No stock/telescopic/foldable/AR style

**Barrel length:** 5.5" / 9"

**Weight w/o mag:** Varies per barrel length and stock



FLYER

### CAR 816

The CAR 816 is a tactical rifle, chambered in 5.56x45mm NATO, with barrel lengths ranging from 7.5" to 16", and features adaptable rails. This modular weapon functions in diverse scenarios, from close-quarters combat to dynamic.

**Calibre:** 5.56 x 45mm NATO

**Operating principle:** Gas-operated, short-stroke gas piston system, rotating bolt

**Modes of fire:** Safe, semi-auto, fully auto

**Trigger type:** MIL-SPEC, 3.4-5.5 kg

**Magazine:** 30 rounds

**Buttstock:** Retractable – 6 positions

**Barrel length:** 7.5"/10.5"/14.5"/16"

**Weight w/o magazine:** 3Kg/3.3kg/3.5kg/3.6kg



VIDEO



**SMALL ARMS | INFANTRY**  
**PRODUCTS**  
**CARACAL**



FLYER

### CAR 817 AR

The CAR 817AR is a centre-fire, gas-operated system tactical rifle, It's designed for the high-end use of law enforcement and military applications.

**Calibre:** 7.62x51mm NATO

**Operating principle:** Gas-operated, short-stroke gas piston system, rotating bolt

**Modes of fire:** Safe, semi-auto, full auto

**Trigger type:** MIL-SPEC

**Magazine:** 20 rounds

**Buttstock:** Retractable – 6 positions

**Barrel length:** 12.5", 14.5" and 16"

**Weight w/o magazine:** 3.9kg/4.1kg/4.3kg



FLYER

### CAR 817 DMR

Tailored for designated marksman roles in an infantry squad, the CAR 817 DMR exemplifies the modern high-precision rifle, bridging the engagement range between a service rifle and a dedicated sniper platform. Chambered in the 7.62x51mm NATO and .308 WIN calibres, and barrel length of either 16" or 18", this rifle is flexible enough for SWAT teams, squad-level military deployments, and marksmen.

**Calibre:** 7.62x51mm NATO (.308 WIN)

**Operating principle:** Short-stroke gas piston system

**Modes of fire:** Safe and semi-auto

**Trigger type:** 2 stage trigger SSA 1.4 - 1.5 kg

**Magazine:** 10/20 rounds

**Buttstock:** Precision sniper buttstock

**Barrel length:** 18"

**Weight w/o magazine:** 4.96Kg



VIDEO



SMALL ARMS | INFANTRY  
**PRODUCTS**  
**CARACAL**



FLYER

### CSR 308

The CSR 308 is a modern high accuracy and lightweight sniper rifle which finds use in all MIL and LE applications in the most demanding environments. Focusing on reliability, safety and operator convenience. The CSR 308 is part of a modern and modular, manual bolt operated dedicated precision rifle family.



VIDEO

**Calibre:** .308WIN

**Operating principle:** Bolt Action System

**Modes of fire:** Safe and fire

**Trigger type:** 2 Stage adjustable precision trigger

**Magazine:** SR-25 Mag type

**Buttstock:** 4 position, telescopic, foldable

**Barrel length:** 24"

**Weight w/o magazine:** 5.07kg



FLYER

### CSR 338

The CSR 338, chambered in the .338 Lapua Magnum calibre, offers unerring accuracy over extended distances. Equipped with a 10-round magazine, and ambidextrous magazine release and safety mechanisms, the CSR 338 embodies versatility.



VIDEO

**Calibre:** .338 Lapua Mag

**Operating principle:** Bolt Action System

**Modes of fire:** Safe and fire

**Trigger type:** 2 Stage adjustable precision trigger

**Magazine:** 10 rounds

**Buttstock:** 4 position, telescopic, foldable

**Barrel length:** 27"

**Weight w/o magazine:** 6.52kg



## SMALL ARMS | INFANTRY PRODUCTS

# CARACAL



FLYER

### CSA 338

The CSA 338 sniper rifle, chambered in .338 Lapua Magnum, delivers excellent accuracy over extensive distances. Meticulously engineered, it meets the exacting demands of Special Forces in even the most rugged terrains. The CSA 338 incorporates comprehensive ambidextrous controls, extended safety and bolt catch levers, a two-position push-through gas regulator, and a titanium firing pin bolstered with state-of-the-art safety enhancements.

**Calibre:** .338 Lapua Mag.

**Operating principle:** Short stroke piston system

**Modes of fire:** Safe, fire and semi-auto

**Trigger type:** 2 Stage adjustable precision trigger

**Magazine:** 15 rounds

**Buttstock:** Adjustable for both length and height

**Barrel Length:** 27"

**Weight w/o magazine:** 6.85kg



FLYER

### CSR 50

The CSR 50 long-range anti-materiel sniper rifle draws inspiration from the mission-proven family of CARACAL sniper rifles, inheriting their ruggedness, reliability and ease of maintenance.

**Calibre:** 12.7×99mm NATO/.50 BMG

**Operating principle:** Bolt Action System

**Modes of fire:** Safe and fire

**Trigger type:** 2 Stage adjustable precision trigger

**Magazine:** 10 rounds

**Buttstock:** 4 position, telescopic, foldable

**Barrel Length:** 29"

**Weight w/o magazine:** 10.4Kg



VIDEO



SMALL ARMS | INFANTRY

PRODUCTS

CARACAL



BROCHURE

## CLMG 556

A belt fed fully automatic lightweight machine weapon. Chambered in 5.56 x 45mm NATO the CLMG 556 delivers rapid and accurate fire power in a compact and lightweight system. With Advanced long stroke gas piston system, the CLMG delivers exceptional reliability in the harshest environments. The CLMG has a compact feeding mechanism, allowing the sights to be mounted directly to the receiver giving excellent accuracy and repeatability.

**Calibre:** 5.56x 45mm NATO

**Feeding:** Belt fed 5.56x45mm M27 link

**Rate of fire:** 700-950 rpm

**Rifling:** 6 Groove 1in7"Twist

**Grip:** Polymer with storage compartment

**Barrel Length:** 16"

**Weight w/o magazine:** 7.8kg (Unloaded without accessories)

**EDGE**



**CYBER DEFENCE  
& SECURE  
COMMUNICATIONS**

**KATIM**

**ORYXLABS**

# CYBER DEFENCE & SECURE COMMUNICATIONS

Keeping communication and data safe through cryptography, cipher development, cyber-force training, security operations centres, network protection software, and more, as well as delivering ultra-secure networking hardware, software and smartphones.

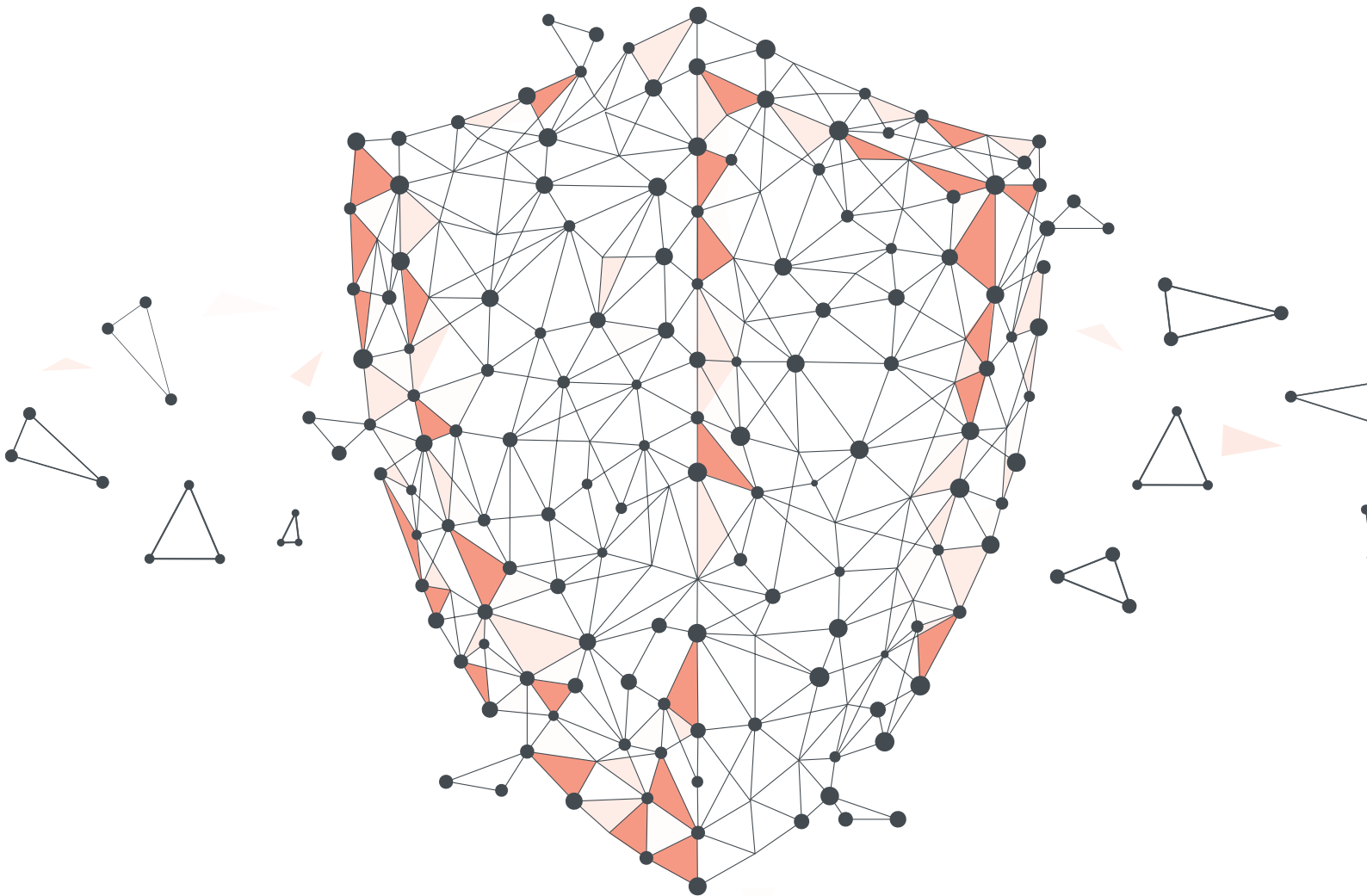



## CYBER DEFENCE & SECURE COMMUNICATIONS

### PRODUCT

# KATIM



### KATIM GATEWAY 9011

An industry-first, next-generation network encryption solution.

- Standards-based or custom national Crypto
- Post-quantum resistant primitives
- Best-in-class security with application-aware encryption
- Four cipher and plain SFP+ ports for pluggable copper or optical transceivers
- L2 or L3 VPN for up to 500 KATIM Gateways in point-to-point and/or mesh configurations
- HW designed for FIPS 140-2 Level 4 compliance



BROCHURE



### KATIM GATEWAY 9001-R

Ultra-secure encryption for the most demanding environments and in-motion deployments

- Standards-based or national Crypto Suite
- Post-quantum resistant primitives
- Up to 1 Gbps bi-directional encryption capacity
- In-device generated, non-exportable peer authentication private keys
- L2 or L3 VPN overlay with full tunnelling
- HW designed for FIPS 140-3 Level 4 compliance



BROCHURE





## CYBER DEFENCE & SECURE COMMUNICATIONS

### PRODUCT

# KATIM



### KATIM GATEWAY 9001

Ultra-secure encryption for small offices and remote locations

- Standards-based or national Crypto Suite
- Post-quantum resistant primitives
- Up to 1 Gbps bi-directional encryption capacity
- P2P and (M)P2MP hub-and-spoke or mesh topologies
- Authenticated key exchange
- Dual-layer asymmetric handshake leveraging both classical and post-quantum cryptography



BROCHURE

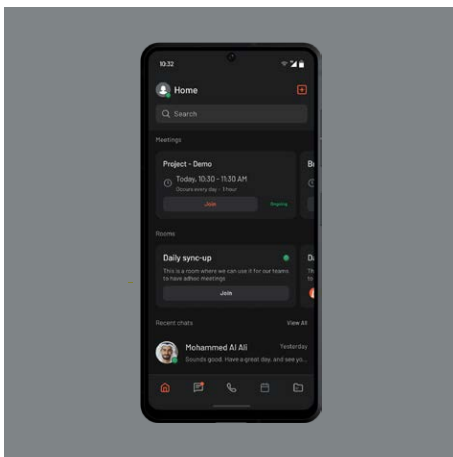

### KATIM X4

The ultra-secure messaging, calling, conferencing and file storage/sharing solution

- End to end encryption with custom crypto support
- Advanced user identity protection
- Flexible hosting options
- Self-manageable by Customer
- Federation with other businesses & public domains (b2b/b2c)
- Optional custom features



BROCHURE



## CYBER DEFENCE & SECURE COMMUNICATIONS

### PRODUCT

# KATIM



### KATIM X3M

In a world where security is paramount, KATIM empowers you to take ownership of your privacy and safeguard your critical communications. Experience the assurance of knowing your data and communications are protected with the KATIM X3M ultra-secure smartphone.

- Qualcomm QCM8550
- KATIM OS
- 16 GB LPDDR5X, 256 GB UFS4.0
- 2G EGSM, 3G WCDMA, 4G TDD & FDD LTE, 5G NR Sub 6 GHz NSA/SA, dual SIM (nano SIM card and eSIM)
- Wi-Fi 6E, Bluetooth 5.3, GNSS, NFC, UWB
- USB Type-C 3.1 gen 1, Interface for extension modules
- 6.5" AMOLED FHD+ with touch sensor Gorilla® Victus® 2.5D glass
- Triple rear cameras (AF + 2x FF) with dual LED flash, FF front camera



BROCHURE



### KATIM SATCOM ELECTRONIC PROTECTIVE MODEM (EPM)

KATIM Satellite Communication EPM Modems are indispensable tools for organisations that require secure, resilient, and reliable communication in environments where threats such as jamming, interference, or cyber-attacks are prevalent. By investing in these advanced technologies, organisations can safeguard their operations, ensure data integrity, and maintain continuity even in the most challenging conditions and hostile environments.

- L Band interface (950MHz to 3150MHz)
- Waveform Modes: PSK Mode, DVB-S2X Mode
- EPM: FH > 1000 hops/sec
- MIL-STD 810, MIL-STD 461 compliant
- Operating Temp: -40°C to +60°C
- Power consumption: < 60W
- Weight: < 12kg



BROCHURE



## CYBER DEFENCE & SECURE COMMUNICATIONS

### PRODUCT

# KATIM



### KATIM GROUND SATELLITE COMMUNICATION SYSTEM

The KATIM Satellite Communication On-the-Move (SOTM) terminal solution enables seamless, real-time communication for tactical Beyond-Line-of-Sight (BLOS) networks. It provides secure, high-speed connectivity for mobile operations, ensuring uninterrupted data, voice, and video communication in challenging environments.

- Ku band frequency
- EIRP 44dBW
- G/T 10dB/K
- Embedded Antenna Control Unit
- MIL-STD 810, MIL-STD 461 compliant
- Operating Temp: -10°C to +55°C
- Power consumption: 400W
- Weight: 58kg



BROCHURE



### KATIM TACTICAL MOUNTED SDR RADIO

KATIM's Tactical Mounted SDR Radio is a robust and versatile communication solution designed for vehicle-mount applications. Supporting both MANET and point-to-point communication, this SDR-based architecture radio excels in harsh environmental operations. Its dual-channel RF bearer capability ensures seamless crossbanding between two frequency bands, making it the ideal choice for tactical datalink applications.

- Operating Frequency 30MHz to 2700MHz
- RF Output (100W V/UHF, 50W L/S)
- Waveform Supported: PSK, OFDM
- MANET Supported
- 2x2 MIMO Configuration
- Channel Bandwidth: Narrowband (Up to 75KHz), Wideband (Up to 8MHz)
- Embedded Encryptor Module
- Supports H.265, G.729
- Interface: N-type (RF), Ethernet (Data/Management)
- MIL-STD 810, MIL-STD 461 compliant



CLICK TO VIEW

BROCHURE



## CYBER DEFENCE & SECURE COMMUNICATIONS

### PRODUCT

# ORYXLABS



BROCHURE



VIDEO

## DISCOVERY

### THE FUTURE OF EXPOSURE MANAGEMENT

DISCOVERY, an award-winning platform helps critical entities gain visibility into their external attack surface and public enterprise digital assets. It is used by nation-scale level organizations to continuously monitor and identify vulnerabilities, misconfigurations, and other security issues 24x7x365.

With DISCOVERY, leaders can rest assured that their organization's external environment will be constantly monitored for security issues.

### UNIQUE FEATURES

- **Exposed asset mapping:** Perform automated full mapping of exposed assets. Get visibility into domains, sub-domains, hosts, asns, netblocks, mail servers, name servers etc. Identify and map relationships.
- **Technology stack:** Get full visibility into the entity technology stack. Using inhouse ~12k rules we can identify over 80k technology platforms. Additional details like open ports, dns, iocs are also available.
- **Issues identification:** Get visibility into vulnerabilities at host, app and cohosting level. Coverage of over 150k known cves along with details of various security misconfigurations.
- **Breached credentials:** Cover over 3800+ up-to-date global breaches to identify 25b+ breached credentials (username, cleartext passwords, hashes, breach name among others).
- **Typosquatted domains:** Use machine learning to identify domains that are similar to entity domains and can be used for malicious purposes (phishing, typosquatting).
- **Actionable insights:** Provide actionable insights to the leadership team via variety of dashboards, remediation overviews and infrastructure change timelines.



## CYBER DEFENCE & SECURE COMMUNICATIONS

### PRODUCT

# ORYXLABS



BROCHURE



VIDEO

## DNS FIREWALL

### SIMPLIFY DNS BASED SECURITY

DNS FIREWALL, an award-winning platform protects users from malware, unauthorized or inappropriate web content and taking actions in real time to mitigate malicious threats and help your organization defend against DNS- based attacks.

Cost-effective and easy to operate, our solution monitors all outgoing DNS traffic from an organization's on-premises and remotely operated computers, tablets, smart sensors and equipment – ensuring those endpoint devices do not access dangerous website.

Implemented from a single software platform, DNS FIREWALL uses machine learning, artificial intelligence and advanced algorithms to assess, in near-real time, the destination of all outbound DNS traffic.

### UNIQUE FEATURES

- **Malicious host identification:** Enhance defense in depth by blocking endpoints from accessing malicious hosts like c2 domains, malware, phishing, ransomware, spyware sites. Filter dga activity & block newly registered domains.
- **Content restrictions:** Allow clients to block access to domains based on parameters like content categories (e.G. Social media, gambling, sports, religion etc.), Geolocation, privacy etc. Configure allow and block lists.
- **Quarantine:** Allow clients to perform a triage after an incident to identify devices that accessed a malicious domain and quarantine them
- **Easy deployment:** Easy deployment that reduces downtime. Supports various mdm applications for smooth deployment.



## CYBER DEFENCE & SECURE COMMUNICATIONS

### PRODUCT

# ORYXLABS



FLYER

## CYBER360

### COMPLIANCE AT SCALE

CYBER360, an award-winning compliance platform that helps organizations to evaluate compliance to various cybersecurity standards (UAE IA, ISO 27001, PCI-DSS, NIST800-53 among others.), track gaps and identify areas requiring greatest focus.

With CYBER360, you can streamline your cybersecurity processes, identify, and mitigate risks, and maintain compliance - all from a single and integrated platform.

Our user-friendly interface and powerful features make it easy for your team to stay ahead of emerging threats and enhance the security maturity of your organization.

### UNIQUE FEATURES

Uncover the comprehensive capabilities of CYBER360 that empower your organization to streamline cybersecurity processes, identify and mitigate risks, and maintain compliance with ease.

- **Comprehensive cybersecurity management:** Gain full visibility into your organization's cyber security posture. Track, manage and monitor status across various security controls.
- **Easy regulatory compliance:** Automate compliance assessments and reporting against various industry standards, including UAE Information Assurance (IA) Regulation, ISO 27001, PCI DSS, among others.
- **Scalable and flexible:** Scale effortlessly as your organization grows. Drive automated technical assessments via integration with our automated Cyber Exposure Management platform DISCOVERY.
- **Expert support and guidance:** Access to a dedicated team of cybersecurity experts based in the UAE, with excellent understanding of organization's GRC needs and trends.



**EDGE**

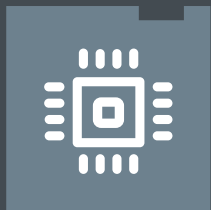

# **ELECTRONIC WARFARE**

**SIGN4L**

**HIGH LANDER**



# ELECTRONIC WARFARE

Leveraging the electromagnetic spectrum to achieve mission success and protect valuable assets across air, land and sea by disrupting, denying and exploiting enemy capabilities, whether drones, guided munitions and missiles, or other kinetic and non-kinetic threats.

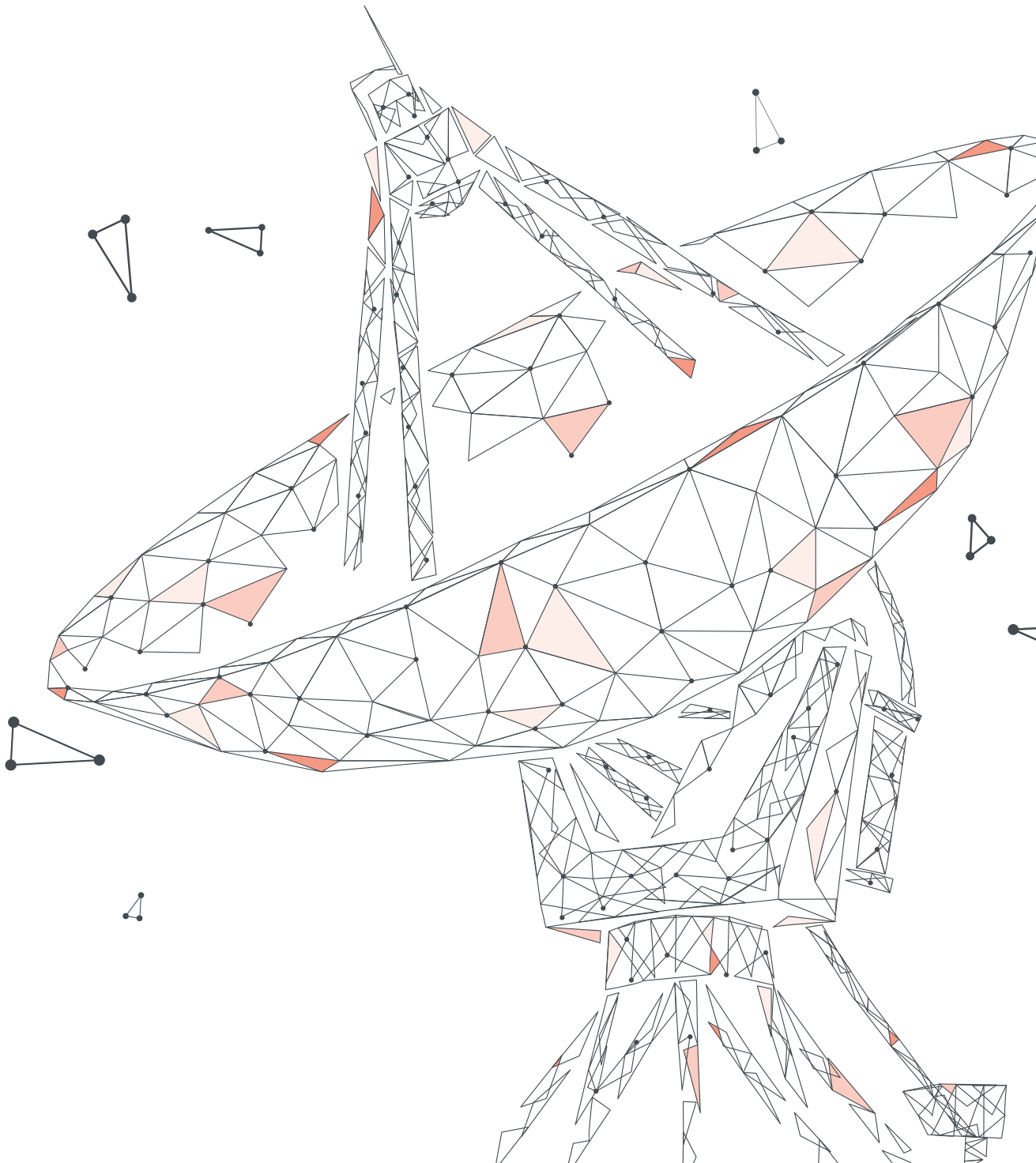



# ELECTRONIC WARFARE | ELECTRONIC ATTACK PRODUCTS SIGN4L



BROCHURE



VIDEO

## V - PROTECT

The SIGN4L V-Protect is a state-of-the-art, mobile, active/reactive high-power jammer system designed to protect vehicles, particularly against remote-controlled improvised explosive devices (IEDs) and drones. This system enables jamming of all common terrestrial and drone RF signal technologies.

Featuring a typical jamming ratio for single threats of <sup>3</sup>1:1 and up to 16 wideband jammers for simultaneous operation across all bands, this powerful system is fully self-contained on the vehicle once installed.

- Mobile operation
- Fully self-contained on vehicle once installed
- Jamming of all frequencies associated with radios, walkie-talkies, mobiles and Wi-Fi across the 20 MHz to 6 GHz bands.
- Up to 16 wideband jammers for simultaneous operation across all bands
- Both active/reactive jamming for maximum coverage
- Typical jamming ratio for single threats <sup>3</sup> 1:1



# ELECTRONIC WARFARE | ELECTRONIC ATTACK

## PRODUCTS

# SIGN4L



BROCHURE

## NAVCONTROL

NAVCONTROL system uses the most advanced GNSS jamming and spoofing measures to provide robust defence against hostile unmanned aerial vehicles. With a typical range of 50km for unprotected platforms, the system is ideal for use along borders and at other strategic locations.

The system produces GNSS denial and emulation signals to safely distance unmanned vehicle threats. The system provides jamming and spoofing of GNSS signals to simulate a contradictory alternative path, thereby protecting an intended area of interest.

- Jams the full GNSS spectrum
- Spoofs commercial GNSS spectrum to protect a specified area of interest
- Combination of jamming and spoofing capability for maximum coverage range
- Typical jamming and spoofing range for unprotected GNSS platform up to 50 km\*
- System fitted into customised, standalone, air-conditioned racks



BROCHURE

## D-PROTECT

D-Protect is an advanced RF and GNSS jamming and spoofing solution that targets drone control to deliver an effective counter-drone solution for enhanced security and control in sensitive areas.

Covering the full GNSS spectrum and targeting command and control, the system has a typical jamming range for unprotected GNSS platforms of up to 10 km. D-Protect is contained in a customised, standalone, air-conditioned case (shared).

- Jams full range of GNSS spectrum
- Jams UAS C2 channels
- Option to spoof a range within the GNSS spectrum to protect an area of interest



## ELECTRONIC WARFARE | ELECTRONIC PROTECTION PRODUCTS

# SIGN4L



### GPS-PROTECT 2

Designed for small form factor requirements, the SIGN4L GPS-Protect 2 uses advanced digital signal processing and array antenna technology to effectively protect GPS receivers from RF interference and/or strong jamming signals.

- Small form factor for mini-UAVs, drones, guided weapons, and portable GNSS receivers
- Counters narrow band (NB) and broadband (BB) jammers
- Compact anti-jamming module
- Three antenna options
- Works with legacy GNSS L1 receivers
- Powered with 12VDC through RP-SMA connector
- Easy installation



BROCHURE

### GPS-PROTECT 4

The SIGN4L GPS-Protect 4 uses advanced digital signal processing and array antenna technology to effectively protect GPS receivers from RF interference and/or strong jamming signals. Encased in a ruggedised mechanical housing, it is ideal for platforms operating in harsh environments.

- Counters narrow band (NB) and broadband (BB) jammers
- Anti-jamming module provided in ruggedised mechanical housing designed to withstand harsh environments
- Customised antenna enclosure to best fit specific platforms
- Works with legacy GPS receivers
- Easy installation



# ELECTRONIC WARFARE | ELECTRONIC PROTECTION PRODUCTS SIGN4L

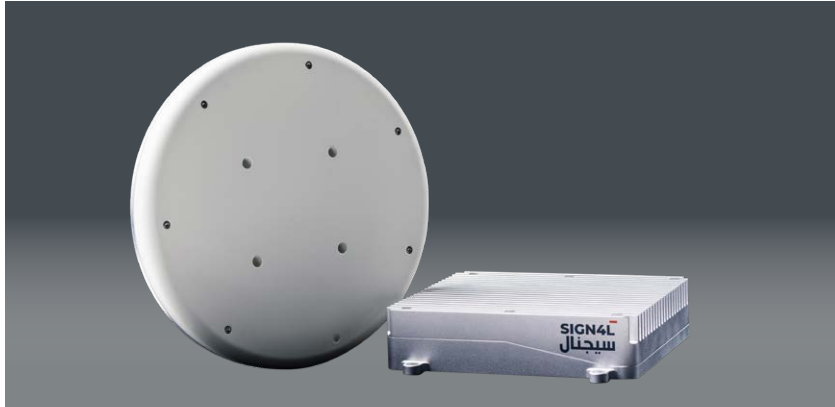

BROCHURE

## GPS-PROTECT 8

The SIGN4L GPS-Protect 8 uses advanced digital signal processing and array antenna technology to effectively protect GPS receivers from RF interference and/or strong jamming signals. With a ruggedised form factor and customisable antenna enclosure, the GPS-Protect 8 is ideal for aircraft, vehicles, vessels and guided weapons.

- Counters narrow band (NB) and broadband (BB) jammers
- Anti-jamming module provided in ruggedised mechanical housing designed to withstand harsh environments
- CRPA antenna enclosure can be customised to best fit specific platforms
- Works with legacy GPS receivers
- 8 antenna array elements
- Installation in aircraft, vehicles, vessels and guided weapons



BROCHURE

CLICK TO VIEW

## BORDERSHIELD

The SIGN4L BORDERSHIELD is an autonomous surveillance system that provides integrated persistent awareness and security for border protection. The solution offers a tactical edge by providing target detection and identification.

### Key features

- Target detection and identification
- Target location
- Cellular identification
- Support for GSM, UMTS, LTE and 5G NSA
- High-end scanner supporting 2G/3G/4G/5G
- Continuous detection of cellular identities with smart switching of antenna sectors



# ELECTRONIC WARFARE | ELECTRONIC PROTECTION PRODUCTS SIGN4L



BROCHURE

## ACTIVECELL-SAR

SIGN4L has developed an aircraft-mounted cellular system for search and rescue operations using a fully software-defined radio. This system can locate targets over 2G (GSM), 3G (UMTS), 4G (LTE) and 5G (NSA) networks.

- Mobile Operation: Compact design facilitates installation on manned or unmanned aircraft
- UI and UX: Pre-programmed missions are possible with the easy-to-operate system
- Robust: Up to 8 high-power base stations for simultaneous transmission across all available networks



BROCHURE

## WIFINDER

WIFINDER is a family of tactical solutions that give law enforcement and homeland security organisations a powerful tool to investigate and gather data intelligence from target devices across the Wi-Fi spectrum.

- Significant capture range
- Discrete and portable form factor
- Real-time collection of Wi-Fi emitters and metadata



# ELECTRONIC WARFARE | ELECTRONIC PROTECTION PRODUCTS SIGN4L

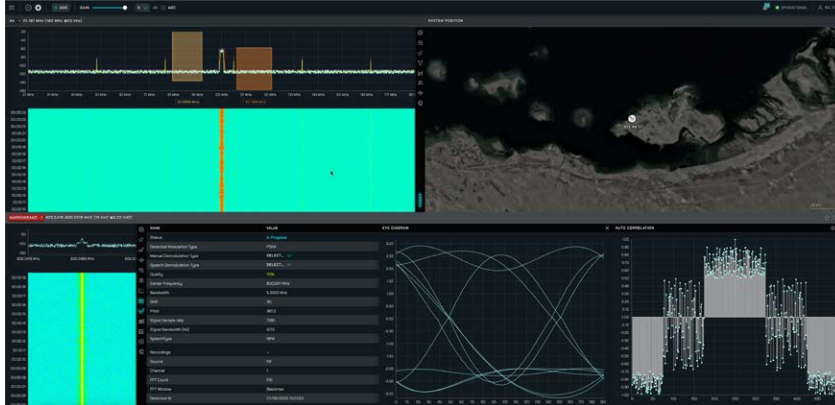

## COMINT

The SIGN4L COMINT solution is designed to capture and analyse signals across a wide frequency range, including UHF/VHF frequencies. With real-time tracking of all signals, COMINT ensures operators and commanders can respond quickly and effectively to signal intelligence.

### Key features

- Real-time signal tracking of all signals
- Frequency range 20MHz – 6000MHz
- Intuitive tactical system user interface
- 2-channel instantaneous capture



## COMJAM

The SIGN4L COMJAM system is a communication jammer and radio monitoring system for fixed-site or mobile electronic warfare and radio monitoring purposes, where primary detection of narrow-band and spread-spectrum signals is effectively countered by wide-band jamming capabilities.

### Key features

- Communication jammer of RF spectrum from 20 MHz to 6 GHz
- Typical jamming ratio for single threats  $\rightarrow$  2:1
- Intuitive command and control software for effective operation

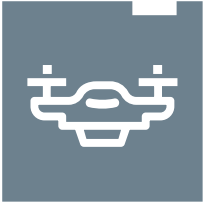

# ELECTRONIC WARFARE | ELECTRONIC PROTECTION PRODUCTS SIGN4L



FLYER

## SKYSHIELD

The SIGN4L SKYSHIELD is a fixed-deployment, state-of-the-art counter-UAS solution contained in a compact, environmental cabinet. It is a high-power RF and GNSS jamming system designed to jam drone frequencies, with a combination of jamming and spoofing for maximum coverage.

The typical jamming range for unprotected GNSS platforms is up to 10 km, while the solution jams the full GNSS spectrum, as well as drone command and control channels with a typical jamming performance of 2:1 from a drone's remote control.

- Standalone air-conditioned cabinet
- Detects and identifies UAVs
- Jams the full GNSS spectrum and drone's command and control channels
- Spoofs commercial GNSS spectrum to protect a specified area of interest
- Combination of jamming and spoofing capability for maximum coverage
- Typical jamming range for unprotected GNSS platform up to 10 km
- Typical jamming performance for command-and-control channels is 2:1 from drone's remote control





## ELECTRONIC WARFARE | ELECTRONIC PROTECTION PRODUCTS SIGN4L



FLYER

### SKYSHIELD-N

KYSHIELD-N is a quick-deploy counter-UAS solution in a platform design that combine jamming and spoofing for reliable point protection. This solution jams the full GNSS spectrum and spoofs the full commercial GNSS spectrum to protect a specified area of interest.

The typical jamming range for unprotected GNSS platforms is up to 10 km, while the solution also jams drone command and control channels with a typical jamming performance of 2:1 from a drone's remote control.

- Jams the full GNSS spectrum
- Jams drone's command and control channels
- Spoofs the full commercial GNSS spectrum to protect a specified area of interest
- Combination of jamming and spoofing capability for maximum coverage range
- Typical jamming range for unprotected GNSS platform up to 10 km (medium range coverage)
- Typical jamming performance for command-and-control channels is 2:1 from drone's remote control



# ELECTRONIC WARFARE | ELECTRONIC PROTECTION PRODUCTS SIGN4L



BROCHURE

## SKYSHIELD-TM

SKYSHIELD TM is a state-of-the-art, trailer-mounted counter-UAS solution that is ideal for quick mobile deployments that combine jamming and spoofing for reliable point protection with the option of external power source for fixed deployment operation.

Detect and identify UAS platforms

- Jams the full GNSS spectrum and drone's command and control channels
- Spoofs the full commercial GNSS spectrum to protect a specified area of interest
- Typical jamming range for unprotected GNSS platform up to 10 km (medium range coverage)
- Typical jamming performance for command-and-control channels is 2:1 from drone's remote control



## SKYSHIELD QD

The SIGN4L SKYSHIELD QD is a state-of-the-art, 4x4 vehicle-mounted counter-UAS solution that is ideal for quick mobile deployment to on-road and offroad locations with the option of external power source for fixed deployment operation.

- Detect and identify UAS platforms
- Jams the full GNSS spectrum and drone's command and control channels
- Spoofs the full commercial GNSS spectrum to protect a specified area of interest
- Typical jamming range for unprotected GNSS platform up to 10 km
- Typical jamming performance for command-and-control channels is 2:1 from drone's remote control



## ELECTRONIC WARFARE | ELECTRONIC PROTECTION PRODUCTS **SIGN4L**



### **ECHO 360**

ECHO 360 system is an advanced technology solution that accurately determines the direction of threats by detecting, identifying, location and tracking radio signals.

When used alongside SIGINT, the ECHO 360 system - which features seven-channel instantaneous capture - supplies accurate information for actionable enemy communication interception.

- Frequency range 100 MHz – 6 GHz
- Tactical system user interface
- 160MHz instantaneous bandwidth
- High performance, integrated, low power <130 W
- 7 channel instantaneous capture



## ELECTRONIC WARFARE | COMMAND & CONTROL PRODUCTS

# HIGH LANDER



FLYER

## VEGA UNCREWED TRAFFIC MANAGEMENT (UTM)

Vega UTM provides real-time airspace awareness enabling coordination of drone fleets and traditional air traffic at any scale.

Vega approves and denies flight plans, identifies and mitigates conflicts, and bolsters traditional air traffic management systems to provide the digital infrastructure the world needs to create a consolidated sky.

The solution provides an intuitive dashboard that can be accessed via desktop or mobile. It displays rich, real-time data that airspace managers use to make informed decisions, including drone flight plans and ID, real-time telemetry, NFZs, weather conditions, and more.

### FEATURES INCLUDE:

- **Live monitoring and identification:** Gathers data from a range of sources to display telemetry on a real-time map and enable conformance monitoring via a central platform.
- **Flight plan approvals:** Provides a central portal for pilots to submit flight plans and autonomously approves, denies or alters them for safe and efficient traffic management at scale.
- **Geo-awareness:** Enables airspace managers to seamlessly define and share airspace constraints for dynamic airspace control.
- **Tactical deconfliction:** Dynamic conflict prevention, preventing problems that arise mid-mission.
- **NCTR:** Integrates with drone radar and soft-kill solutions for complete airspace control and protection of sensitive sites.



# HIGH LANDER



FLYER

## ORION DRONE FLEET MANAGEMENT

Orion DFM is a drone-agnostic software platform that gives you complete command over your drone fleet, no matter the size.

Create missions via the intuitive dashboard and watch in real time as your fleets carry them out autonomously - or take direct command from anywhere in the world.

With no limit to the number of drone missions the platform can run simultaneously, Orion is a powerful and versatile tool that broadens the planning horizons and mission possibilities for all types of multi-drone operations, whatever the terrain or situational constraints.

### FEATURES INCLUDE:

- **Payload control:** Direct control of drone hardware from the dashboard - gimbal adjustment, delivery units, speakers, microphones, etc.
- **Cockpit mode:** Manual control of in-flight drone with a pilot's eye view from the camera. Drones can be operated from thousands of miles away.
- **Share link:** Creates a web link to the live video stream of any of your drones for sharing with third parties as required.
- **Object detection:** Detects, identifies and counts people and vehicles. Drones can also track a chosen object even if it is moving quickly.
- **Hot replacement:** Autonomous dispatch of a replacement drone when an in-mission drone is low on battery, for seamless mission continuity.
- **Collision avoidance:** Real-time monitoring and automated navigation adjustments to prevent mid-air conflicts.

**EDGE**



**RADARS &  
ELECTRO OPTICS**

# RADARS & ELECTRO OPTICS

Empowering intelligence, surveillance and reconnaissance (ISR), as well as offensive and defensive guidance and targeting through advanced radar and electro-optical systems that meet the needs of defence, security and public safety entities.

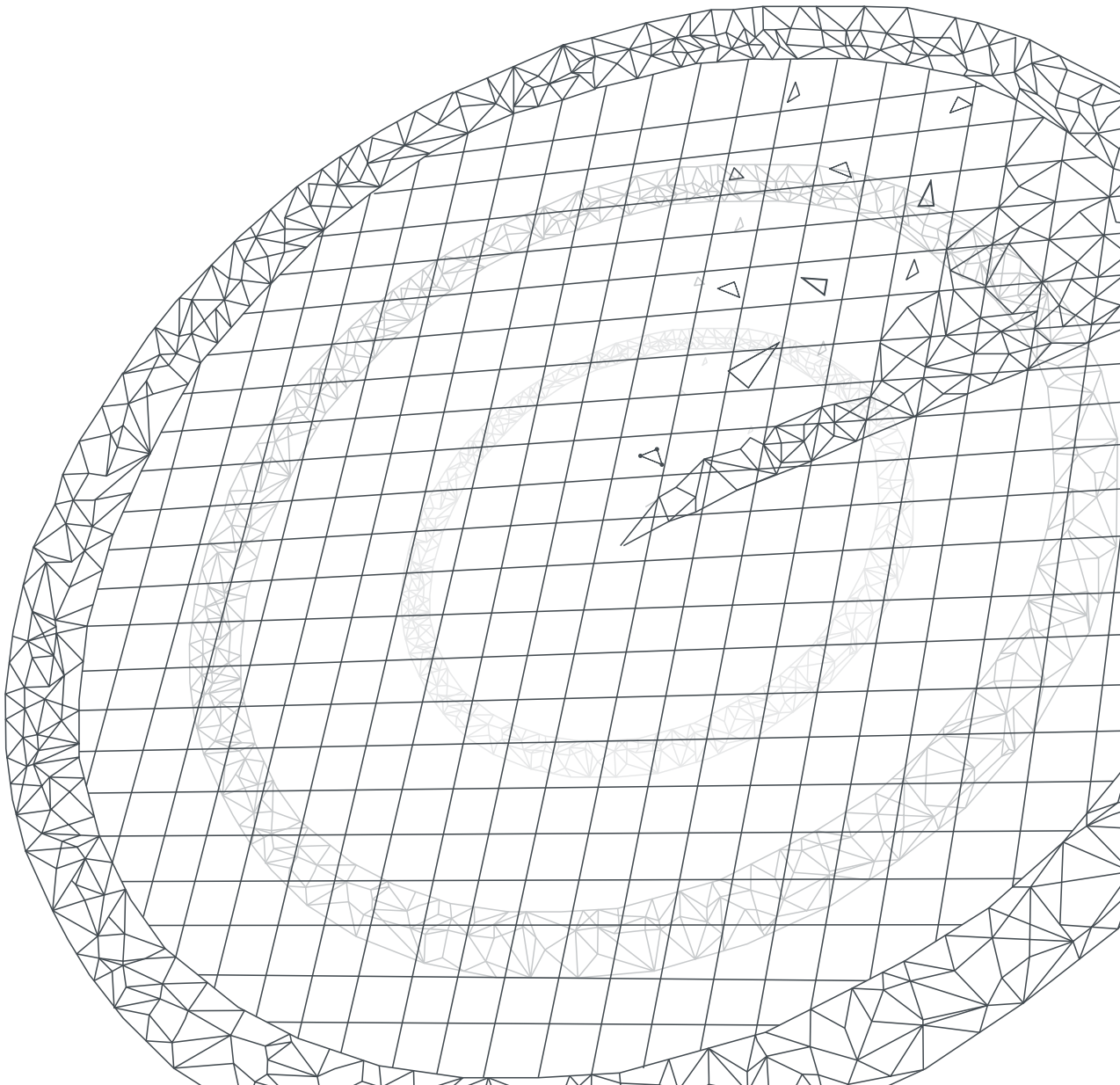



**RADARS & ELECTRO OPTICS**

**PRODUCT**

**EDGE**



FLYER

## **KASHIF 600**

The KASHIF 600 is a compact and lightweight electro-optical stabilized, gimballed tactical system designed for UAVs and ground robotics. It provides exceptional reconnaissance, surveillance, and tracking, making it the perfect solution for tactical military operations.

- Compact weight of 2.74 kg.
- 250 mm height and 180 mm diameter.
- 2-axis stabilized gimbal.
- Motion range of 360° pan and -10° to +80° tilt.
- Uncooled Longwave IR camera with continuous focus.
- Eye-safe laser range finder.
- High resolution day camera.





## RADARS & ELECTRO OPTICS

PRODUCT

EDGE



FLYER

### KASHIF 700

The KASHIF 700 is a compact and lightweight electro-optical stabilized, gimballed tactical system designed for UAVs and ground robotics. It excels in reconnaissance, surveillance, targeting and tracking, making it an ideal solution for tactical military operations.

- Compact weight of 4.4 kg.
- 280 mm height and 350 mm diameter.
- 2-axis stabilized gimbal.
- Motion range of 360° pan and +10° to -80° tilt.
- Laser designator and eye-safe laser range finder.
- Uncooled Longwave IR camera with 7x optical zoom.
- High-definition day camera.



**RADARS & ELECTRO OPTICS**

**PRODUCT**

**EDGE**



FLYER

## **MIRSAD X**

MIRSAD X is a gyro-stabilized multi-spectral electro-optics imager. Equipped with cutting-edge image processing, it enables real-time detection, tracking, localization, and targeting of objects of interest.

Ideal for supporting laser-guided munitions and general maritime and border surveillance, the MIRSAD X system integrates seamlessly into various ground and naval platforms.

- Cooled Mid-Wave IR camera with continuous zoom.
- High power laser designator and eye-safe laser range finder.
- Shortwave IR and visible spotters.
- Full high-definition day camera.
- 2-axis gyro-stabilized pedestal.
- Motion range of 360° pan and -20° to +70° tilt.



## RADARS & ELECTRO OPTICS

### PRODUCT

# EDGE



## MIRSAD NG

MIRSAD NG is an advanced land system designed for automatic detection, recognition, and identification in various environmental conditions. It is optimized for maximum sensor range performance, using highly sensitive sensors and advanced video enhancement algorithms. The system can be integrated with other solutions, providing a comprehensive approach to defence and homeland security operations.

- Cooled Mid-wave IR camera with continuous optical zoom.
- Compact Shortwave IR spotter.
- Wide and Narrow FOV Full High-Definition Day Camera
- 2-axis Gyro-stabilized pedestal.
- Motion range of 360° pan and -35° to +20° or -10° to +70° tilt.
- Laser pointer and optional Eye-safe laser range finder.



## RADARS & ELECTRO OPTICS

### PRODUCT

# EDGE



FLYER

## MIRSAD R

The MIRSAD R is a cutting-edge, multi-spectral electro-optical system designed for long-endurance UAVs, fixed-wing aircraft, helicopters, and vertical take-off and landing vehicles. It delivers superior four-axis gyro-stabilized imagery, multi-spectral capabilities, advanced image processing, and a laser designator, providing precise geo-localization for optimal surveillance, reconnaissance, and target acquisition.

- Large common aperture and multispectral spotter telescope: MWIR NFOV spotter, Day spotter and SWIR spotter.
- High-definition Mid-wave IR camera with continuous zoom.
- Full high-definition day camera.
- Advanced Laser Target Designator Range Finder.
- Precise Laser pointer and illuminator.
- Gyro-stabilization 4-axis gimbal.
- Motion range of 360° pan and -120° to +90° tilt.



## RADARS & ELECTRO OPTICS

### PRODUCT

# EDGE



FLYER

## TRACK EYE 80/100

The Technology & Innovation TRACK EYE, in 80mm and 100mm diameter versions, is an electro-optical, infrared, stabilised, gimballed tactical system for drones, offering a very small payload of less than 0.4 or 0.6 kg. It delivers precision stabilisation and both day and night capabilities.

- Small tactical payload for drones
- Precision stabilisation
- Day and night capabilities
- Robust design built to withstand harsh environments
- Real-time data transmission



**RADARS & ELECTRO OPTICS**

**PRODUCT**

**EDGE**



FLYER

## **ALQ-500P**

The ALQ-500P is an ESM/ECM airborne pod that features state-of-the-art DRFM and ECM techniques. Compatible with fixed- and rotary-wing aircraft and both supersonic fighter and low-speed UAV flight profiles, the ALQ-500P can protect a wide range of aerial platforms from diverse radar-guided threats.

**Dimensions (L x W x H):** 3.3 m x 0.45 m x 0.42 m

**Aircraft type:** Fixed wing (fighter, transport, mission), Rotary wing and UAVs (medium/big)

**Weight:** 290 kg

**Power consumption:** 2.1kVA (115VAC 400Hz) 30W (28VDC)

**Frequency range:** 2-18 GHz

**Other characteristics:** State-of-the-art DRFM and ECM techniques



## RADARS & ELECTRO OPTICS

### PRODUCT

## EDGE

### NEMUS COMPACT

Nemus Compact is a multi-threat AESA (active electronically scanned array) radar suitable for use in active protection systems (APS), counter-UAS systems, and intelligence, surveillance, target acquisition and reconnaissance applications across both air and land domains.

- 360° angular and 90° elevation
- Light, compact and portable
- Countermeasure agnostic, easy integration
- 4D radar (DTRMs solid-state based)
- Electro-magnetic saturated environments resistant
- Digital AESA radar
- Digital beamforming
- Fully digitised: high-speed data processing
- Data source for surveillance and mission systems
- High resolution and high precision
- 5th module for top-attack protection



FLYER



## RADARS & ELECTRO OPTICS

### PRODUCT

# EDGE

### MTR-1

The MTR-1 Radar provides multifunction AESA radar for ground-based air defence simultaneous 360° surveillance capabilities up to 50 km for a range of aerial defence solutions, including air surveillance, weapon location and fire ranging, threat tracking and classification and drone detection.

- Full Digital AESA in S-Band
- Extended use of ECCM capabilities
- Multifunction operation for search, track, engage and kill assessment
- Operation in ground-fixed, on-the-move and naval platforms
- Architecture design for high availability in remote areas



FLYER





## RADARS & ELECTRO OPTICS

### PRODUCT

# EDGE

## NEMUS

Nemus is a multi-threat AESA radar and active protection system for counter UAS and ISTAR systems. Light, compact and made for on-the-move, this system handles detection, identification and tracking for diverse incoming threats, including UAVs, ATR, ATGM, RPG & kinetic energy ammunition. Offering easy integration, it is countermeasure agnostic.

- 360° angular & 90° elevation
- Made to be on-the-move
- Light and compact
- 4-D radar (TRMs solid state-based)
- Electro-magnetic saturated environments resistant
- Resistance to unfavourable environmental conditions
- Digital AESA radar
- Detection, identification & tracking
- Data source for surveillance and mission systems
- Aerial and land surveillance
- High resolution and high precision
- UAVs, ATR, ATGM, RPG & kinetic energy ammunition
- Fully Digitalized: high-speed data processing
- 5th module for Top Attack protection
- Future proof: smart technology for counter-APS systems
- Multiple simultaneous hostile fire detection
- Countermeasure agnostic, easy integration



## RADARS & ELECTRO OPTICS

### PRODUCT

# EDGE



FLYER

## TAWAQ-1

TAWAQ-1 is a short-range, low-altitude air-surveillance 3D X-band radar that provides detection and tracking of aerial objects, including micro-UAVs. Capabilities include automatic object classification and digital signal processing.

- X-band frequency
- AESA technology
- GaN technology
- Low-level air surveillance
- Minimum detection range of 150 m
- Maximum detection range of up to 15 km
- Continuous 360° surveillance providing 3D object detection
- Full circle or sector scanning modes
- Micro-UAV detection and tracking
- Automatic object classification
- Designed for flexible deployment



## RADARS & ELECTRO OPTICS

### PRODUCT

# EDGE

## TAWAQ 2

TAWAQ-2 is a ground-based 3-D surveillance radar suited for border protection, coastal surveillance, and counter rocket, artillery and mortar (C-RAM) use. With four panels, it provides 360° coverage.

This S-band staring array radar features a high update rate to provide persistent surveillance and tracking over critical geographic areas, whether land or sea borders, or other high-value locations.

- Modern, compact, software defined
- High update rate
- Staring array radar
- Classification
- Multipath mitigation



FLYER

**EDGE**

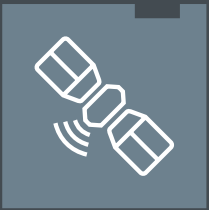

**SPACE**

**FADA**  
فضاء

# SPACE

Developing UAE sovereign space IP and expertise in the manufacture, assembly, integration, testing, and operation of cutting-edge satellites, payloads and platform subsystems.





**SPACE**  
**PRODUCT**  
**FADA**  
فادا



BROCHURE

## AIN SATELLITE

The FADA AIN is a low-earth orbit (LEO) optical satellite that provides very high-resolution images for use in maritime surveillance, monitoring, and search and rescue, as well as environmental and climate change science monitoring and data collection.

### KEY FEATURES

- Very High-Resolution Imaging
- Consistent Daytime Imaging Precision
- Data Empowerment for Innovators
- High Agility
- High Speed Data-Downlink



**SPACE**  
**PRODUCT**  
**FADA**  
**فادا**

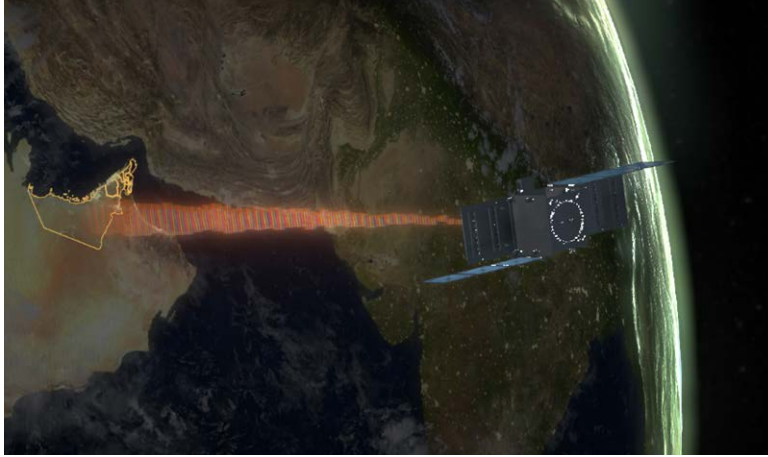

BROCHURE

## SIRB SATELLITE

The FADA SIRB is a low-earth orbit (LEO) synthetic aperture radar satellite that provides vital imaging data for use in maritime surveillance, monitoring and search and rescue, as well as environmental and climate change science monitoring and data collection.

### KEY FEATURE:

- Very high-resolution & quality imaging
- All-weather, day imaging
- High Speed Data- Downlink
- Compatible with scan strip spot acquisition mode
- High duty cycle up to 3% of the orbit
- Phase array antenna technology with electronic beam steering
- Empowers scientists and engineers with valuable data
- Wide swath and broad look angles ensure low revisit time.

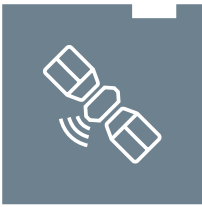

## SPACE PRODUCT FADA فادا

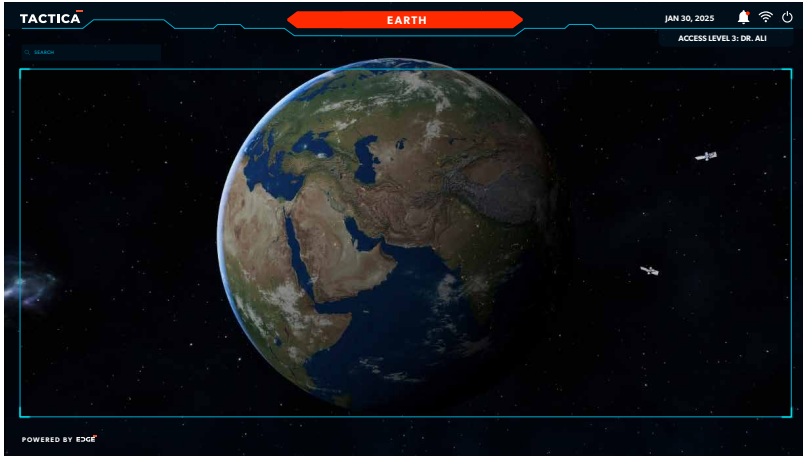

BROCHURE

## TACTICA

The FADA Tactica is an advanced AI-powered geospatial intelligence platform designed for large-scale monitoring and tactical operations, enhancing situational awareness, operational efficiency, and decisionmaking across security, defense, education, and civilian sectors.

### KEY FEATURES

- Voice-Conversational Interaction
- Advanced AI Capabilities
- Real-Time Data Access and Multi-Source Data Fusion
- Agentic Decision Making and Predictive Intelligence
- Adaptive Learning
- Interactive 3D Visualisation
- AI-Based Alerts and Reporting
- Secure, Robust, and Scalable



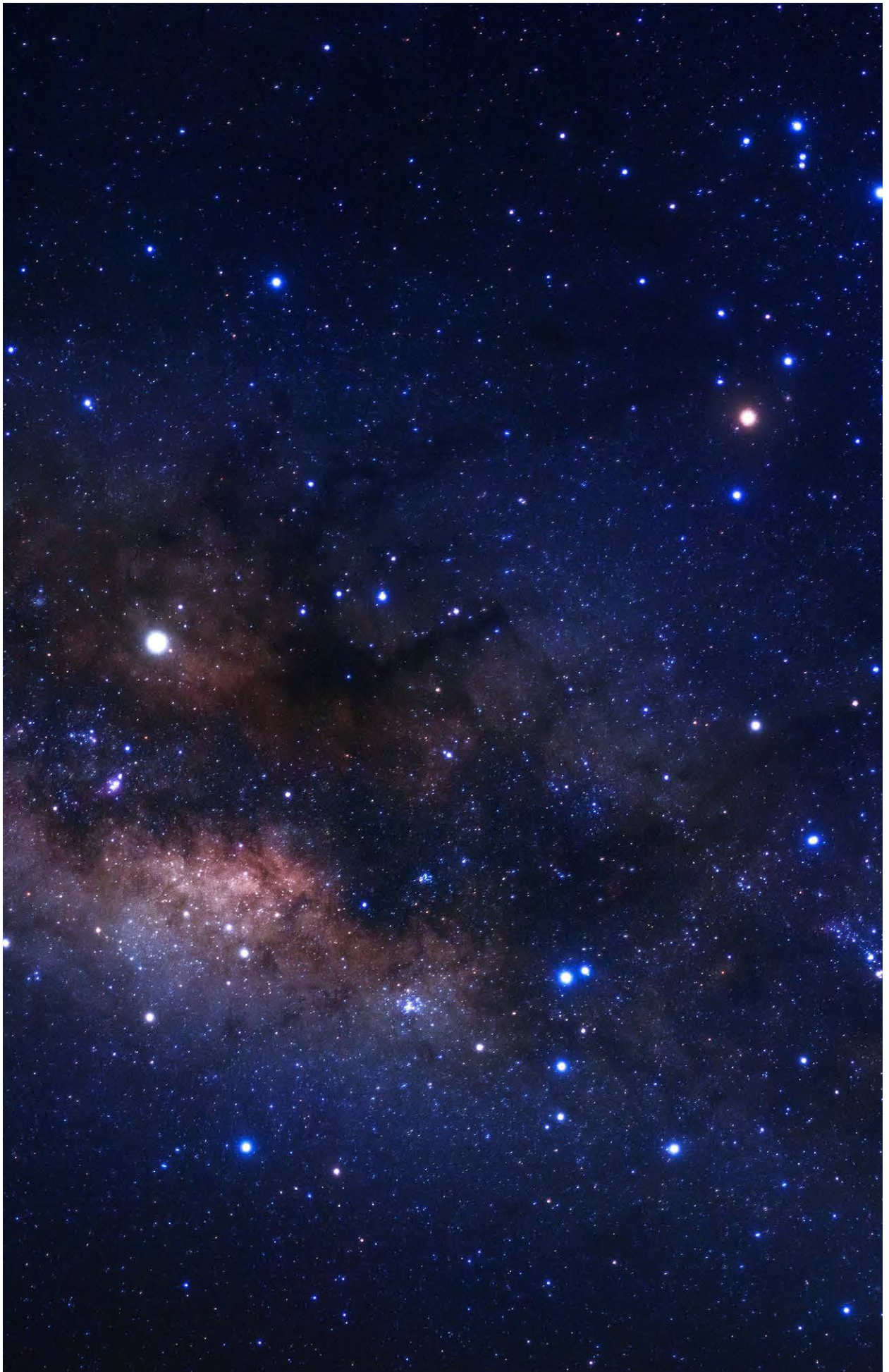

**EDGE**



**MRO**

**AJSB**  
ABU DHABI SHIP BUILDING

**AL TAIF**

# M R O

Making sure platforms and systems are primed for every mission by providing world-class, best-practice lifecycle maintenance, repair, overhaul and engineering – no matter the requirement or timeline.

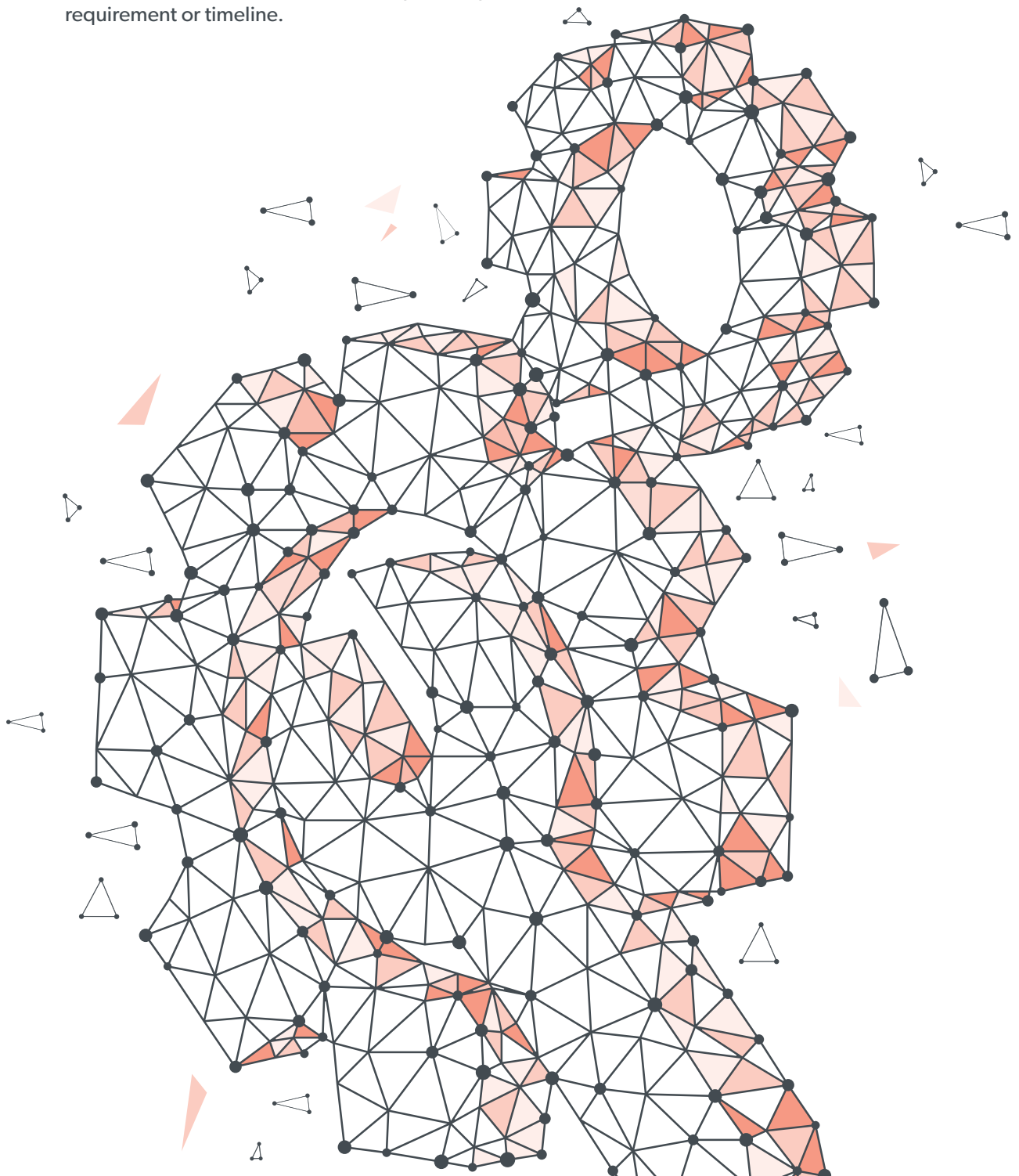



## MRO | MAINTENANCE REPAIR & OVERHAUL SERVICES

**ADSB**  
ABU DHABI SHIP BUILDING



### MAINTENANCE & REPAIR

We offer maintenance and repair services for the military vessels operating in the region. Our qualified and experienced workforce, modern infrastructure and processes enable us to repair and upkeep vessels to stringent marine standards and testing requirements. Our key services include midlife, major, and navigational refits, dry-docking, overhauling of all types of main and auxiliary machineries and the maintenance of Nav-Com equipment and Weapon Systems.



### THROUGH LIFE SUPPORT (TLS)

We deliver customized TLS services to ensure the operational readiness and long-term sustainability of military ships. Our TLS offerings cover the entire lifecycle of the vessels and it includes engineering and development of ILS elements, In-Service Support, Class Management, Maintenance Management, Refit Management, Inventory & Supply Support Management, Data Management, and the Management of Workshops & Technical Stores. Our TLS services ensures the highest level of mission readiness throughout the operational life of the vessels, while optimizing their Life Cycle Cost.



**MRO**  
**SERVICES**  
**ADSB**  
ABU DHABI SHIP BUILDING



## MECHANICAL SERVICES

Our mechanical shop is equipped with sophisticated machine tools, cranes and an environment controlled workspace. Our highly-skilled machinists, millwrights and mechanical fitters offer specialist repair, refurbishment and maintenance, ensuring rapid turnaround, quality and efficiency.

We can repair and overhaul main and auxiliary engines, bow thrusters, propulsion systems, rudders, hydraulic machinery, valves, pumps, coolers and heaters and more.



## PIPING WORKSHOP

Our piping workshop offers services such as profile cutting, pipe bending and fitting, and welding procedures. It houses the latest automated equipment for indoor prefabrication before transferring to vessels for installation. Other equipment includes:

- Overhead cranes
- Pedestal grinding machines
- Hydraulic pipe bending facilities
- Pallet lifters
- Drilling machines
- Speed cutter
- Blasting machines
- Thread cutting equipment



**MRO**  
**SERVICES**

**ADSB**  
ABU DHABI SHIP BUILDING



## ELECTRICAL SERVICES

High-quality workmanship at ADSB's electrical workshop provides comprehensive services, including:

- Troubleshooting and repair of motors and generators
- Power systems (AC & DC)
- Lighting systems
- Switchboards
- Control systems and panels

The calibration laboratory at the workshop can repair various types of metres including multi-metres, clamp metres, panel metres, isolation metres, and pyrometers.

We also work in close collaboration with specialist suppliers to enable the refurbishment of accommodation units.



## OUTFITTING

From minor refurbishments to major refits, our carpentry, sheet metal and insulation shops are fully equipped to manage high quality maritime outfitting.

We also work in close collaboration with specialist suppliers to enable the refurbishment of accommodation units.



**MRO**  
**SERVICES**  
**ADSB**  
ABU DHABI SHIP BUILDING



## BLASTING, PAINTING AND HULL TREATMENT

We undertake a range of bespoke hull treatments, as well as extensive tank coating, and surface preparation and painting of underwater surfaces, main decks, engine rooms, funnels, masts, chain lockers, anchors and chains.

Our Mina Zayed facility carries out hull treatments with environmentally-friendly hydro-blasting robots. Our Mussafah yard also offers hull treatments with grit blasting systems.



## MAINTENANCE AND REPAIRS (COMMERCIAL VESSELS)

Working with strategic maritime partners for two decades, we have developed world-class expertise in commercial ship repairs and services. From vessel conversions to dry-docking maintenance services, we have completed complex projects on diverse commercial ships, including offshore supply vessels, diving support vessels, and superyachts.

With more than 900 employees and a 330,000m<sup>2</sup> drydock, our main yard in Mussafah features state-of-the-art mechanical, welding, electric, composite, and fabrication workshops. The synchro lift at the yard can accommodate vessels up to 80m x 20m and 2,000 tonnes.



**MRO**  
**SERVICES**

**ADSB**  
ABU DHABI SHIP BUILDING



## YARD SERVICES

We offer comprehensive yard services, backed by expert riggers, divers, and yard-cleaning personnel. Our services include docking and undocking of vessels, yard-cleaning, and disposal of garbage. We also maintain ready-to-use mobile equipment such as forklifts, shuttle lifts, and mobile cranes.



## OFFSHORE RIG FABRICATION

With extensive in-house expertise and a network of industry alliances with API and ASME-certified partners, we deliver maintenance and refurbishment of rigs and platforms. We also undertake top-side fabrication for the offshore oil & gas sector and provide steel fabrications support to offshore EPCI and





MRO | CONVERSION  
SERVICES

**ADSB**  
ABU DHABI SHIP BUILDING



## SHIPS

Leveraging our ship building and ship repair expertise, ADSB offers design, engineering, manufacturing and implementation of all types of ship conversion projects. Our teams carry out projects of all sizes and types for military and commercial customers at our Class LR- and Class BV-certified facilities and state-of-the-art drydock.

From modifications, refits and upgrades to meet new mission, compliance or technology requirements, to complete structural redesign and transformations, our customers benefit from exceptional quality and craftsmanship, timely delivery, and cost-effective pricing

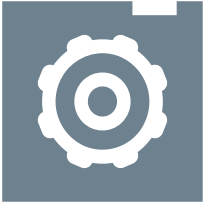

MRO | WAREHOUSING  
SERVICES

**ADSB**  
ABU DHABI SHIP BUILDING



## WAREHOUSING FACILITIES

Our warehouses and storage areas are strategically located to ensure prompt implementation of projects. These units are controlled through a highly organised stock control system. Four large air-conditioned warehouses, six open spaces, and satellite stores facilitate storage and distribution at project sites. A shipyard warehouse allows storage of all critical project-specific items and stock items needed in day-to-day operations.



MRO | MISSION SYSTEMS  
SERVICES

**ADSB**  
ABU DHABI SHIP BUILDING



## MISSION SYSTEMS INTEGRATION

ADSB is proud to provide an extensive portfolio of mission systems solutions that cater to the diverse needs of both military and commercial vessels. Our commitment to excellence extends across various facets of our offerings:

- Installation and Commissioning
- Diverse OEM Systems
- Innovation and Adaptability
- Customized Solutions



MRO | PRODUCTION

SERVICES

**ADSB**  
ABU DHABI SHIP BUILDING



## FABRICATION FACILITIES

At ADSB, our dedicated steel and aluminium fabrication shops are fitted with advanced machinery and technologies, and supported by a highly skilled team. Working in close partnership with our clients, we can undertake everything from major repairs to the construction of modular units with advanced outfitting and the latest 3D modelling.



## SMALL BOAT CONSTRUCTION (SBC)

Our Small Boat Construction division manufactures landing crafts, high-speed interceptors, and immediate support vessels for customers from the GCC and beyond. This division also operates a state-of-the-art composite boat-building facility. Spread across 9,000m<sup>2</sup>, it can construct and repair composite vessels up to 30 metres in length.



MRO | TBD

SERVICES

**ADSB**  
ABU DHABI SHIP BUILDING



## INTEGRATED LOGISTICS SUPPORT (ILS)

At ADSB, we combine traditional ILS engineering practices with cutting-edge Shipbuilding 4.0 technologies, such as the Internet of Things (IoT), Big Data Analytics, Artificial Intelligence (AI), Augmented Reality (AR), and Virtual Reality (VR), to revolutionize the delivery of Integrated Logistics Support. By leveraging these advanced technologies, we enhance operational efficiency, optimize asset management, and provide predictive maintenance solutions that improve the reliability and availability of the vessels.



# MRO | LAND VEHICLES SERVICES AL TAIF



FLYER



VIDEO

## LAND VEHICLES – MRO SERVICES

Our comprehensive MRO services are part of our integrated lifecycle support to military fleets. Our MRO processes are controlled by an ISO 9001-certified quality management system that covers a wide range of military vehicles, components and small arms. We provide complex, extensive and premium-quality maintenance services, delivered against rigorous timelines in order to maximise vehicle and other asset availability, while ensuring business efficiency and continuity.

### SERVICES INCLUDE

- Vehicles rebuild
- Vehicles and components electronics and electrical repair & optics
- Components repair ( engines transmissions, differentials)
- Vehicles and components upgrade
- Components refurbishment
- Vehicles interior and exterior body work, painting and welding
- Product integraion
- Fabrication



MRO | LAND VEHICLES

SERVICES

AL TAIF



## SUPPLY CHAIN MANAGEMENT

Provide complete supply chain management solution, including data - driven supply chain management, material requirements planning. we ensure mission readiness, ontime delivery.

Our supply operations enhance AL TAIF's competitive advantage by relying on seamless partnership with OEM's ensuring proper quality parts for our customers

### OUR CAPABILITIES

- Receipt, storage, issue, and delivery of spares and repairable
- Contingency planning and war reservations
- Warehousing and inventory control
- Order fulfilment and distribution
- Material requirements planning
- Demand analysis and reporting
- Preservation and packaging
- Demand analysis
- Vendor quality control
- Inventory control
- Cataloguing

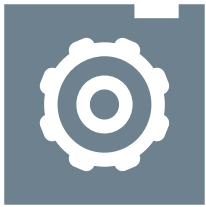

MRO | LAND VEHICLES

SERVICES

AL TAIF



## TECHNICAL TRAINING

AL TAIF takes a systems approach to training for all types of workforce enhancement and development programmes; we deliver military maintenance doctrine training to prepare officers to lead maintenance depots. AL TAIF also designs and delivers quick modular training updates to ensure technicians in the field have the latest skills and techniques.

### OUR CAPABILITIES

- Tailored curriculums build through training needs analysis (TNA)
- Systems approach to training (SAT)
- VR and AR maintenance training
- Mechanical, electrical-electronics and allied trade training
- Instructor certification courses





MRO | LAND VEHICLES

SERVICES

AL TAIF



## ENGINEERING

Our engineering team develop innovative solutions, upgrades and technology integration across a wide range of land platforms and systems that help strengthen client capabilities.

### OUR CAPABILITIES

- Capabilities
- Preventive and Predictive solution
- Failure analysis
- Material Testing
- Modelling and Simulation
- Vehicle improvement and Development Reverse Engineering and Manufacture
- New Technology application study
- System integration and design



MRO | LAND VEHICLES

SERVICES

AL TAIF



## CALIBRATION AND TESTING SERVICES

Our state-of-the-art calibration laboratory is a trusted and respected calibration services that supports the UAE Armed Forces in assuring and maintaining the quality of its monitoring and measuring equipment.

### OTHER CAPABILITIES & SERVICES INCLUDE:

- Electrical calibration
- Temperature calibration
- Balance calibration
- Pressure calibration
- Torque calibration
- Dimensional calibration



**MRO | LAND VEHICLES**

**SERVICES**

**AL TAIF**



## **MAINTENANCE, REPAIR AND OVERHAUL**

Providing Depot Level Maintenance, Repair and Overhaul services, comprehensive set of In-house services and capabilities. Provide complete vehicle, component and platform rebuild comprehensive vehicle overhaul down to the frame, refurbishment, modernization and upgrades.

### **CAPABILITIES:**

- Vehicles rebuilds
- Product integration
- Components rebuilds (engines, transmissions, differentials)
- Vehicles and component electronics and electrical repair and Optics
- Vehicles and components upgrade
- Components refurbishment
- Vehicles interior and exterior body work
- Painting and welding
- Fabrication



MRO | LAND VEHICLES

SERVICES

AL TAIF



## FLEET PROGRAM MANAGEMENT

Highly experienced life cycle management program of land platforms and systems to help customer rapidly, efficiency and effectively deploy world-class program management system.

Support Projects of any scale and complexity, working to build customer in-house capacity to organize and control timely repair of large fleets of equipments, platforms and premises.

### CAPABILITIES:

- Maintenance and lifecycle planning for equipment, platforms, and premises
- Facilities management planning, organising, coordinating, documenting, and supervising
- Preventative, corrective, and scheduled maintenance planning
- CAPEX asset replacement and upgrade planning



**EDGE**



# **ENGINE & SUB-SYSTEMS**

**POWERTECH**

**ADVANCED**  
CONCEPTS

## ENGINE & SUB-SYSTEMS

Designing, developing and manufacturing high-performance piston, expendable turbojet, and medium- and large-size turbofan engines, as well as subsystems such as fuzes, TV seekers, advanced actuator systems, and mission-variable warheads.

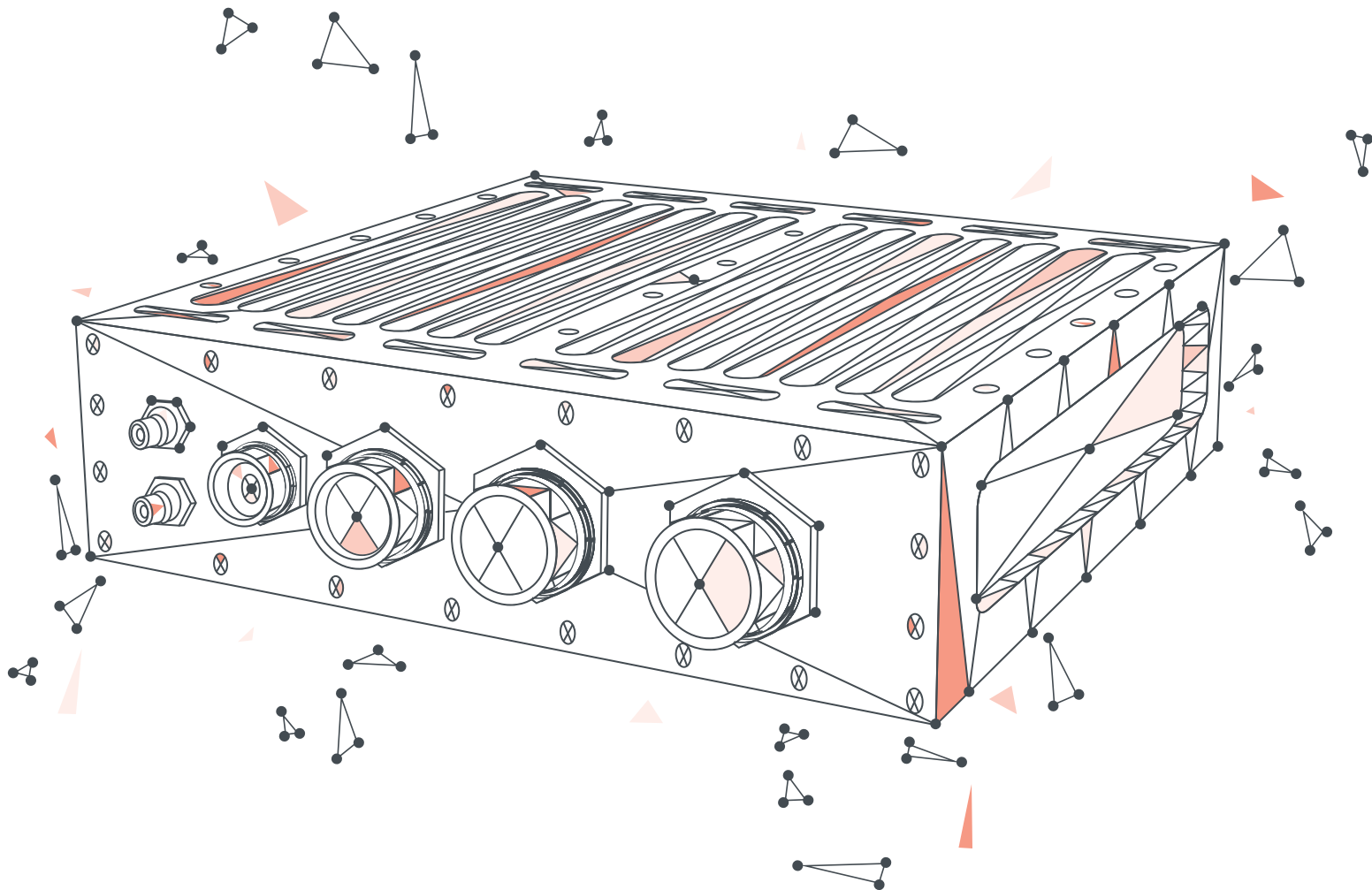

# POWERTECH



## P145i

The POWERTECH P145i is a boxer 2-stroke, 6-cylinder fuel-injection engine with separated lubrication, a flat engine configuration, and a shorter and lighter crankshaft. This makes for easier installation into medium-altitude, long-endurance UAVs and other light aerial vehicles.

**Length:** 980 mm (approx. 1,000 mm from pulley to muffler end)

**Width:** 610 mm (approx. 650 mm from left cylinder head cover to right cylinder head cover)

**Height:** 720 mm (actual: 750 mm)

**Engine type:** Piston

**Operating principle:** 2-stroke

**Fuelling:** Electronic fuel injection

**Oiling:** Separate oil injection

**Cooling:** Air-cooled

**Engine displacement:** 1.8l

**Number of cylinders:** 6 cylinders

**Horsepower:** 145 hp



FLYER



## X100

The POWERTECH X100 is a micro-jet engine for precision-guided air munitions. Suitable for autonomous platforms, it features a simple single-shaft engine with a one-stage centrifugal compressor and one-stage axial turbine.

**Diameter:** 232 mm

**Length:** 640 mm

**Weight:** 17 kg

**Nominal thrust SLS:** 1,000 N

**TSFC @ Nominal thrust:** 32.6 g/kN.s



FLYER







## ENGINE & SUB-SYSTEMS PRODUCTS

**ADVANCED**  
CONCEPTS

### ESAD-50

The ADVANCED CONCEPTS ESAD-50 is an electronic safety arming device designed for munitions of 50mm diameter and greater. It features FPGA-controlled inertial safety measures, as well as flight computer arming/disarming control.

**Diameter:** 50 mm

**Height:** 100 mm

**Power-on:** Disarmed  
FPGA-controlled inertial safety measures  
Flight computer arming/disarming control



FLYER

### G70 ACTUATOR

The ADVANCED CONCEPTS G70 Actuator is a self-contained fin actuation mechanism for the G70. Supporting precision guidance, the actuator incorporates a mechanical and electrical system, as well as motor control electronics.

The system, which runs 250mm long by 70mm in diameter faces no export controls, making it an ideal subsystem for the G70 missile.

**Diameter:** 70 mm

**Length:** 250 mm



FLYER



## ENGINE & SUB-SYSTEMS PRODUCTS

**ADVANCED**  
CONCEPTS



FLYER

### MK84 – ERK

The ADVANCED CONCEPTS Gliding Kit for the MK84 bomb is a low-cost kit that converts an MK84 bomb into guided loitering air-to-ground munition. With a maximum range of 60 km and top altitude of 33,000 ft, the Gliding Kit brings additional mission capabilities to the MK84 and its applications.

The Gliding Kit adds GNSS guidance, creating a low-cost but effective system that features foldable wings for ease of transport and storage.

**Wingspan:** 3,000 mm

**Length:** 3,725 mm

**MTOW:** 1,150 kg

**Payload:** 1,000 kg bomb

**Maximum operational altitude:** 33,000 ft

**Maximum range:** 60 km

### GUIDANCE KIT FOR ARTILLERY WEAPONS

**Diameter:** 122 mm

**Weight:** Warhead 13 Kg

**Accuracy [CEP]:** ↔ 10 m

**Fuze Type:** Point Detonating and Proximity

**Advanced GNSS Navigation**

**Compatible with standard:** 122mm Rocket Motor

**EDGE**



**PRECISION  
ENGINEERING**

**EPI**

**HALCON**

# PRECISION ENGINEERING

Offering state-of-the-art manufacturing and consulting services for top-of-the-line, highly engineered and complex components, delivered through precision processes to customers in the aerospace, defence and commercial sectors.

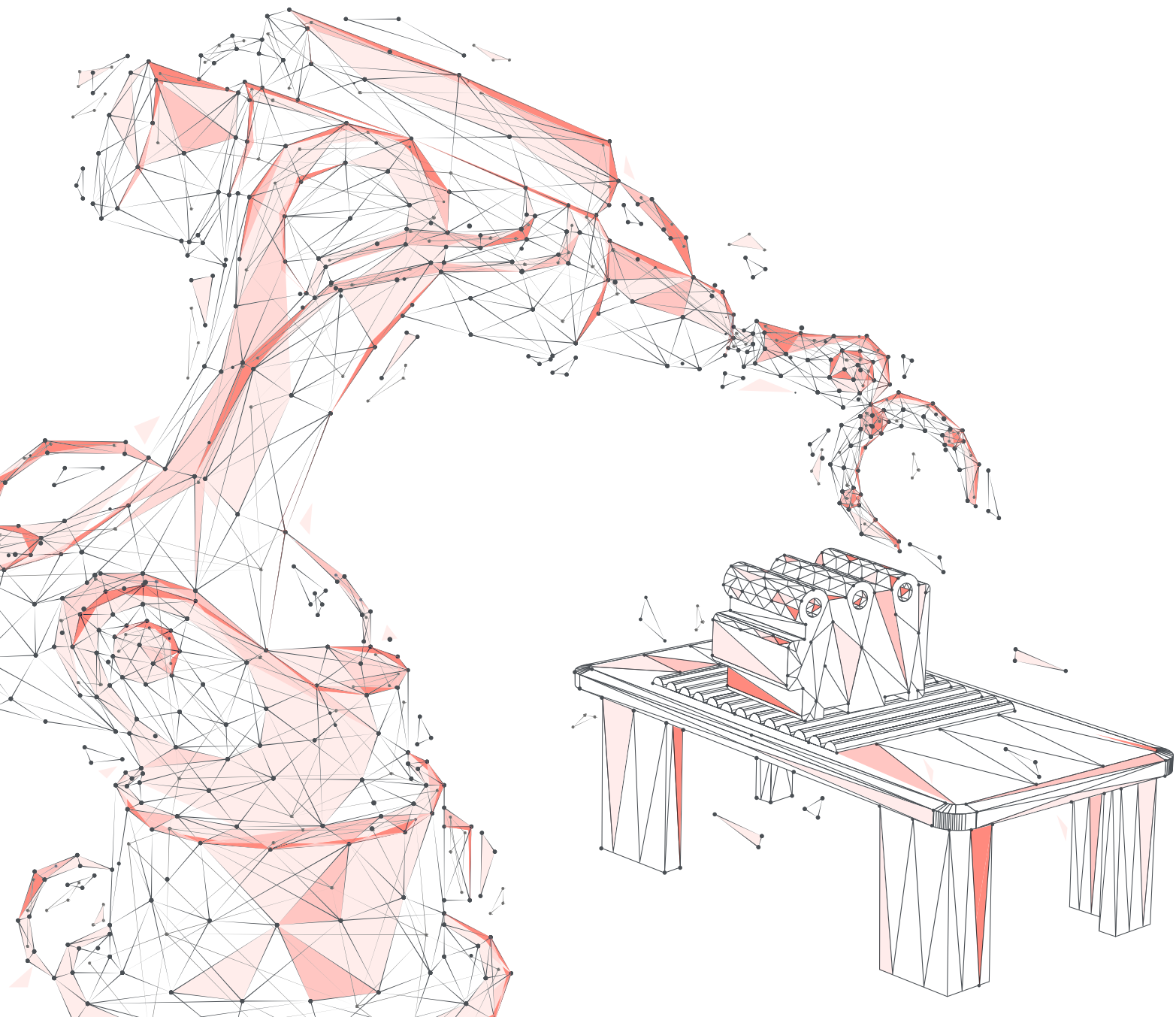



## PRECISION ENGINEERING SERVICES

# EPI

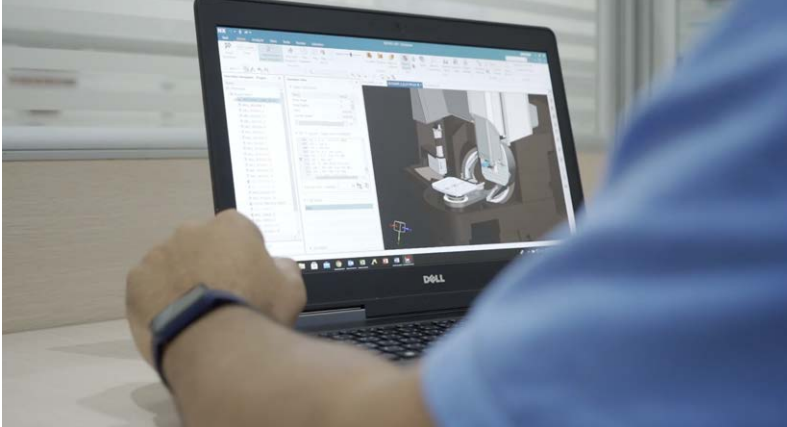

FLYER

## MANUFACTURING ENGINEERING

We support product development from early-stage capacity studies and prototyping, to final manufacturing and production process design. Making this possible are EPI's highly skilled team of:

- CAD/CAM Designers and Programmers
- Manufacturing and Application Engineers
- Toolmakers

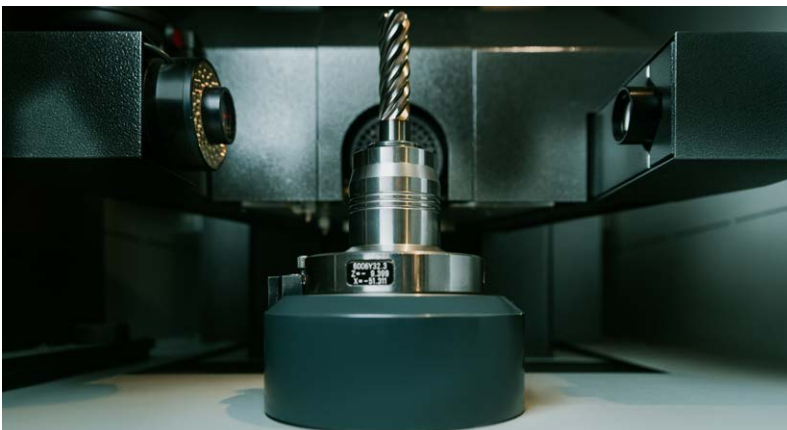

## CUTTING TOOL MANUFACTURING

All our cutting tools and re-sharpeners come with the assurance of quality and precision.

We have an advanced technology edge to produce high-quality tools for all types of operations, such as milling, drilling, reaming, etc. Further, our capabilities extend to measuring, inspection, and other critical functions such as:

- Custom-made cutting tools for all operations
- Manufacture and re-sharpening of carbide and HSS tools
- Five-axis cutter grinders to tool re-sharpening
- Self-measurement probes and 3D simulators
- Measuring and inspection of cutting tools



## PRECISION ENGINEERING SERVICES EPI



### CALIBRATION LAB

Dimensional, force, torque, electrical, furnace We perform in-house calibration for equipment within our scope of processes (excluding master equipment). This may include covering dimension force, torque, electrical, and furnace.

Our calibration offering is handled by our dedicated software platform that tracks all related data and notifications. This allows recall of equipment as per the defined verification period, supported by a qualified team.



### INSPECTION AND LABORATORIES

We make sure that all our products and manufacturing processes are constantly monitored and controlled to meet our internal and customer needs. That's why we focus on training our employees for operator qualifications and reassessment programmes. This helps us promote self-inspection deployments across departments.

Our Statistical Process Control framework goes a step further by helping us improve sampling methods and redefines key characteristics required to ensure alignment with our Quality Policy.

Our inspection process is handled with conventional equipment like:

- Vernier caliper
- Micrometres
- Digital height gauge measuring equipment
- Coordinate Measuring Machines (CMM) Up to 7m in length
- Hexagon machine with PCDMIS for offline programming



## PRECISION ENGINEERING SERVICES EPI

### SURFACE TREATMENT

Revolutionizing Surface Treatments with EDGE's EPI Solutions.

Our special process engagements are carried out at two main shops with an overall footprint of approximately 8000 square metres.

- Chemical Processing
- Non Destructive Testing
- Surface Enhancement
- Paint Process
- Part Marking
- Laboratory



FLYER

### METALLIC LABORATORY

We are equipped to control the properties of materials, including various aluminium grades, titanium, steel and stainless steel, to meet industry benchmarks. We achieve this through monitoring that includes incoming inspections, detailed inspection during the parts manufacturing stage, and review following heat-treatment processes.

Our test capabilities include:

- Material surface hardness with machines capable of achieving Vickers, Knop, and Rockwell A, B, C methods
- Microstructure analysis (including moulding)
- Chemical analysis with spark optical emission spectrometer (OES)
- Electrical conductivity measuring of non-ferrous material (aluminium grade/Eddy currents)







## PRECISION ENGINEERING SERVICES EPI

### MACHINING AND ASSEMBLY

Precision machining solutions to meet key industry requirements.

Our machining capabilities are designed to meet key industry requirements with the following offerings:

- Three-and five-axis milling machining soft and hard materials
- Turning
- EDM
- Laser , TIG , MIG and ARC welding
- Rectification process (roll forming, shot peening by ultrasonic and blasting)

EPI also offer equipping and Sub-Assemblies process:

- Faster installation
- Torqueing
- Bushing
- Bearing installation

### ENGINEERING SOLUTIONS

Our manufacturing engineering solutions include:

- Process capability studies
- Precision machining
- Industrialization
- CAD/CAM programming
- Application engineering
- Manufacturing process design
- Production process development





## PRECISION ENGINEERING SERVICES HALCON



BROCHURE

### ADVANCED MANUFACTURING

HALCON's Special Manufacturing Division boasts cutting-edge facilities with 5-7 axis CNC machines, laser cutting and welding, a quality assurance lab and plastic injection moulding.

From nano-sized to half a metre in length, our Special Manufacturing Division can cut, shape and create from all types of metallic parts, including specialised aluminium machining. Adding to these advanced capabilities, fast production is supported through automated in-house robotic solutions



### SURFACE TREATMENT

HALCON's Special Manufacturing Division offer comprehensive turnkey surface coating and painting solutions for small to large components and equipment. With superior technology, including the UAE's only cathodic electrodeposition (CED) coating facility, and years of experience, we are the leading local expert in providing military-grade anti-corrosion protection that helps you assure performance.

Our surface treatment capabilities include:

- Cathodic Electro-Deposition (CED)
- Chromate Conversion (Type II, Class 1A & Class 3)
- Anodizing (Type II & Type III)
- Zinc Plating (Type V & VI)
- Phosphating (Type M & Class 2)
- Passivation (Nitric)
- Quench Polish Quench (Nitriding)
- Testing Lab



## PRECISION ENGINEERING SERVICES **HALCON**



### **ELECTRICAL MANUFACTURING**

HALCON's Special Manufacturing Division turnkey solutions in state-of-the-art printed circuit board (PCB) and cable harness production. The specialised facilities deliver products built to perform in the most demanding operational scenarios.

Our PCB production facility is a 2800 square metre smart factory that is capable of board assembly, system integration, quality assurance testing and mass production of single-sided, double-sided and multi-layered PCB's up to IPC class 3.

Our cable and wiring harness facility produce customised cable and wire harnesses, and provide engineering design services for all types of electromechanical, power supply, industrial or other uses. The harnessing production line serves customers in industries such as telecommunications, oil and gas, healthcare and defence with electronic assemblies that deliver exceptional reliability and durability.

**EDGE**



**TESTING &  
TRAINING  
SERVICES**

**BEACON RED**

**HORIZON**

**REMAYA**

**ADASI**

**LAHAB**  
MILITARY SERVICES

# TESTING & TRAINING SERVICES

Offering industry-leading helicopter pilot training and military-ready leadership and practical skills training to prepare the frontline forces and civilian personnel required for the complex world of tomorrow.





## TRAINING & SERVICES

### SERVICES

# BEACON RED

## LANGUAGE TRAINING SOLUTIONS

BEACON RED offers mission-relevant Language Training Solutions in various languages and dialects to support critical mission accomplishment in technical and professional fields.

We offer synchronous and asynchronous Language Training Solutions, ranging from basic acquisition through advanced enhancement to include immersions, isolated immersions, scenario-based training, critical thinking, and analysis.

## TRANSLATION SERVICES

BEACON RED offers bespoke Translation and Interpretation Services to help clients achieve their international ambitions. With a team of expert linguists and advanced content management systems, we deliver precise communication of key messages and client intent. Our comprehensive language solutions include document translation, telephonic interpretation, video call and face-to-face transcription, proofreading, web localisation, and services in over 60 language pairs. Tailored to meet unique visions, our services ensure the highest standards of linguistic excellence.

## DUE DILIGENCE

Sensitive positions in your organisation are a security imperative and must be encompassed by trust and resiliency. Our Due Diligence service provides extensive background verification capabilities and bespoke services for due diligence/background investigations. Whether for individual hiring, inclusive of all background check elements and personnel threats, or vendor, third party, and access checks, BEACON RED ensures that every aspect of your daily interactions and hiring process is vetted and verified.

## NATIONAL SECURITY CAPABILITIES

NSC excels in addressing national security challenges through innovation, strategic partnerships, and thought leadership. With a deep understanding of client needs, we deliver turnkey solutions for governments and adjacent entities worldwide. Our offerings include intelligence services, Digital Overwatch, BEACON RED Intelligence Cell, and due diligence for personnel and supply chains. Additionally, we provide training and advisory services to enhance capabilities in law enforcement, intelligence, critical infrastructure, and specialist skills. By remaining at the forefront of national security, we aim to deliver high-quality capabilities that meet evolving global demands.

## NATIONAL SECURITY IN A BOX

BEACON RED's National Security Centre of Excellence is a comprehensive solution for all national security missions. The Centre is comprised of training, advisory support and technology that can scale and expand to absorb additional missions, delivered by elite professionals.



## TRAINING & SERVICES

### SERVICES

# BEACON RED

## RANGE ON WHEELS

Our RANGE ON WHEELS (ROW) automation technology combines the latest innovations in defence training with groundbreaking capabilities in cybersecurity. Through ROW, an advanced, portable emulation generator, users may create numerous different training scenarios for cyber operations, integration, manipulating new technology, or developmental operations orchestrations. By using off-the-shelf cyber-range scenarios, ROW is able to emulate various environments. ROW can be fully integrated with both physical and virtual devices.

### RANGE ON WHEELS (ROW)<sup>TM</sup>

- Range Automation
- Portability/On-Premise
- Devops Orchestration
- Devops Catalogue
- Hybrid (Virtual & Physical) Integration
- Training and Simulation

### LABS ON WHEELS (LOW)<sup>TM</sup>

- Auto Lab Deployment
- Portability/On-Premise
- Interoperability Testing
- Defence Integration
- Hybrid (Virtual & Physical) Integration
- Independent Verification & Validation

### DATACENTER ON WHEELS (DOW)<sup>TM</sup>

- Turnkey Solution - Ready to be parachuted into any mission
- Simply Turn on And Go
- Portable Compute Power
- High and Low Speed Network and Security Capabilities
- Highly Mobile Design for Rapid Deployment
- Fully Integrated Solution
- Shockproof Military Graded Racks

### FORENSIC LAB ON WHEELS (FLOW)<sup>TM</sup>

- Disk Forensic Acquisition
- Mobile Forensic Acquisition
- Forensic Image Storage
- Forensic & Intelligence Analysis
- Highly Mobile Design for Rapid Deployment
- Fully Integrated Solution
- Shockproof Military Graded Racks



## TRAINING & SERVICES

### SERVICES

# BEACON RED

## HUMAN AND ORGANISATIONAL PERFORMANCE

### CAPABILITY DEVELOPMENT

We support our clients with comprehensive Capability Development Solutions. Designing competency frameworks to provide transparent career pathways, developing roles and entity specific job descriptions. BEACON RED provides technical and behavioural assessments of employees and compares their skillsets against competencies with detailed insights into areas for staff development.

### PROFESSIONAL DEVELOPMENT

We provide a comprehensive range of professional development services to prepare individuals and teams for future leadership and management challenges. With extensive experience and a vast library of courses, we offer tailored, workplace-focused training pathways for staff at all levels. Our programmes include nationally and internationally accredited awards, certificates, and diplomas, delivered in partnership with leading UAE and UK awarding bodies such as ACTVET, Highfield International, ILM, CMI, and CIPD.

### LANGUAGE DEVELOPMENT

Online English Language development courses support exam preparation for University and Immigration-related cases. Additionally, BEACON RED offers development courses for business language skills which enhance report writing and professional language needs in the workplace.

### TRAINING SOLUTIONS

BEACON RED empowers next-generation professionals with innovative training solutions designed to inspire and develop individual talent. Leveraging a diverse team of subject matter experts, we deliver comprehensive curriculums and cutting-edge training platforms. Recognised by Anthology with Catalyst Awards in 2023 and 2024, our best-in-class e-learning suite supports individual and organisational development goals. Combining expert knowledge, instructional design, and advanced educational technologies, we create interactive, engaging content focused on practical application and real-world case studies. Our tailored training solutions ensure measurable workplace benefits, making us a leader in professional development.

### UAE NATIONAL QUALIFICATION PROGRAMMES

BEACON RED is an Approved Training Provider (ATP) under ACTVET & Ministry of Education.

As an ATP, we support partners to create, accredit and deliver entity specific programmes that are nationally recognised via the national vocational qualifications framework, providing learners with job-ready skills needed to excel in the workplace and a national qualification as recognition of their learning.

### NATIONAL QUALIFICATION DEVELOPMENT

BEACON RED can support accrediting corporate training programmes so that they are recognised nationally or internationally. This adds value by facilitating pathways to further education or future learning, if required.





## TRAINING & SERVICES

### SERVICES

# BEACON RED

### ACCREDITED APPRENTICESHIP PROGRAMMES

Working with NAFIS, we can develop nationally accredited qualification programmes at a Certificate, Diploma, Bachelors and Masters level to support the development of Emirati professionals to ensure that your organisation has a talent pipeline of high-calibre candidates.

### MISSION TECHNICAL ACADEMY (MTA)

As global threats grow more sophisticated, the technical expertise required to counter them must evolve. BEACON RED's Mission Technical Academy prepares the next generation of national security professionals to confront future challenges with mental fortitude and the most advanced skills and techniques.

### ACCREDITATION SERVICES

BEACON RED drives the expansion of accredited training in defence, security, and law enforcement sectors by offering both existing national and international qualifications and developing new UAE-specific vocational programmes to address existing gaps. Our services include Qualifications Development, and Accreditation Advisory & ATP Compliance.

Committed to enhancing vocational education, we deliver impactful training aligned with national and international benchmarks.

### ADVANCED PSYCHOMETRICS AND ASSESSMENT

BEACON RED uses a systematic, data-driven approach to enhance workplace performance by evaluating individual potential through advanced psychometric testing and assessments. Our methods identify unique traits that drive agile performance while highlighting potential risks, enabling decision-makers to improve recruitment and selection processes. By leveraging dynamic talent analytics, industry expertise, and research, we uncover workforce trends and predict vulnerabilities, empowering clients to make informed, strategic talent management decisions. Our solutions deliver actionable insights for mission-critical talent-related decisions, transforming how organisations identify, develop, and retain top talent.

### PEOPLE ANALYTICS SYSTEM (PAS)

The People Analytics System (PAS) is a proprietary testing platform by BEACON RED that allows our People Analytics team to administer tailored assessments electronically, either unsupervised or proctored. It hosts and administers psychometric and aptitude testing by leveraging advanced technologies to assess complex higher order cognitive and personality constructs. The PAS platform is hosted fully in the UAE on our on-premise highly secure servers.

### HUMAN PERFORMANCE OPTIMISATION

We offer a holistic approach to personal growth, empowering individuals to achieve their full potential across all aspects of life and enhancing organisational effectiveness. Our bespoke programmes focus on five key areas: Physical Health and Fitness, Mental Clarity and Focus, Emotional Regulation, and Spiritual Growth Peak Performance. This integrated approach motivates lasting change and maximises individual and team potential.



## TRAINING & SERVICES

### SERVICES

# BEACON RED

## MISSION TECHNOLOGY

### GRC SERVICES

Governance, Risk, and Compliance (GRC) is the backbone of a resilient and forward-thinking organisation. By integrating robust governance frameworks, proactive risk management, and unwavering compliance, GRC empowers businesses to navigate complexities with confidence. BEACON RED's team of international subject matter experts have not only led GRC programmes across all industries, but have worked closely with governments to develop forward-thinking nation-wide policies. At BEACON RED, we believe that security exists to empower the organisation to achieve its goals. Trust our GRC team to elevate your operational standards and safeguard your enterprise with precision and expertise.

### TSS

BEACON RED's Technical Security Solutions teams design and deploy complex security centric systems and solutions that provide advanced security management capabilities for enterprise and homeland security initiatives. Such initiatives include solutions for Critical Infrastructure Protection, Safe City and Digital Twin Initiatives, Wide Area Monitoring and Response, Waterways Protection and Border Monitoring Projects. BEACON RED tailors the solutions to maximise customers' capabilities by bundling Technology, Tactics and Procedures for complying with best practices and most advanced threat management response.

### TSCM

BEACON RED provides tailored and unique capabilities in the region by offering Technical Surveillance Counter Measures services and solutions. TSCM services are provided for periodic TS inspections in executive offices and areas subjected to potential TS threats. BEACON RED TSCM teams equally design and deploy RF shielded environments such as required in SCIF, Secure Communication Rooms and Research and Industrial Facilities which require protection from radio emissions.

### SPECTRUM DOMINANCE

BEACON RED RF specialists provide a wide range of spectrum related services such as Broadband Spectrum analysis, Wi-Fi spectrum optimisation, RF Hunting, and persistent TSCM monitoring. BEACON RED StratoScout and StratoScout AI solutions are designed for corporate enterprises, as well as other civilian and military applications. BEACON RED StratoScout and StratoScout AI solutions can be land-based, sea-based or encapsulated into autonomous monitoring solutions.

### ADVISORY SERVICES

BEACON RED provides tailored security centric Advisory and Professional Engineering Services to corporate clients and governmental agencies. Such engagements contribute to clients' capability development or provide instant subject matter expertise in specific missions. Missions include Infrastructure Development, Front-End Engineering, Safe City Initiatives and Complex Communications Systems Development.



## TRAINING & SERVICES

### SERVICES

# BEACON RED

### MISSION ENGINEERING

At the backbone of technology, Mission Engineering forges and shapes the future of national security and homeland security in the LEA, intel and military domains by building and engineering state-of-the-art technical solutions. From data centres to fly-away-kits, Mission Engineering integrates cutting edge technology, supporting missions aligned with client needs, turning aspirations and possibilities into reality. Mission Engineering has successfully built strategic and tactical integrated solutions to support and strengthen national security matters, uniting technology and innovation, enabling our clients to fight the odds, protect and defend nations.

### INTEGRATION SERVICES

BEACON RED specialises in delivering comprehensive solutions integration across diverse technology domains, including cyber and physical security, technical security services, and command and control systems. Our technology-agnostic approach ensures that we identify and implement the best solutions tailored to customer specific needs. By leveraging a wide range of technologies and partnering with leading vendors, we provide customised, efficient, and reliable integration services that enhance security and operational efficiency.

### CWE-NET

The Classified Workspace Environment Network (CWE-Net) is a secure turnkey solution designed to protect sensitive data, IP, and corporate trade secrets while meeting stringent industry standards, including NIST, NISPOM, FIPS, and UAE IA. It features an air-gapped network infrastructure tailored to customer needs for rapid implementation and enables secure collaboration across entities. CWE-Net supports SECRET and TOP SECRET data with advanced capabilities such as SMIME-encrypted email services, watermarking, data classification, sandboxing, and one-way diode data ingestion. Its military-grade shockproof racks with hyper-converged infrastructure ensure portability and resilience. This solution provides organisations with robust tools and security to meet mission-critical demands.

### GUARDIAN SERVICES

BEACON RED offers unparalleled security through custom, defensive solutions powered by expert analysts, threat hunters, and forensic specialists. With advanced technologies, we provide cyber threat intelligence, incident response, advisory, and investigative services to safeguard national security. Our digital monitoring of underground forums and firsthand knowledge of threat actors protects against vulnerabilities in government systems.

At the core of our services is the Guardian Integrated Threat Intelligence Platform, designed by our multilingual intelligence team. The platform offers secure access to threat reports, specialist support, and advanced searches across billions of data points. It features modular tools for dark web monitoring, social media tracking, breach databases, attack surface analysis, and risk-based cyber intelligence. Our experts are on-call to support UAE sovereignty and security.



## TRAINING & SERVICES

### SERVICES

# BEACON RED

## OTHER SERVICES

### CLIENT-CENTRIC SERVICES - PROJECT MANAGEMENT

Client-centric Services - Project Management prioritise clients' needs and goals, ensuring tailored solutions for each project. This approach involves active collaboration, transparent communication, and adaptive planning to align with clients' visions. By focusing on client satisfaction and personalised service, these services foster strong relationships and deliver projects that meet or exceed expectations. Key benefits include enhanced client trust, project efficiency, and successful outcomes that reflect clients' unique requirements and objectives.

### HR TRANSFORMATION

Our HR Transformation team is passionate about shaping the future of work through culture, collaboration, and innovation. We empower organisations to embrace change as a growth opportunity, leveraging expertise in change management, digital transformation, and communication.

Our services cover everything from market analysis to talent acquisition, change management to total rewards compensation. But beyond the services, we're here to support organisations on their journey, providing guidance, empathy, and a human touch every step of the way.

### SPEARHUNT

Spearhunt specialises in global talent acquisition, connecting businesses with niche technical talent across continents. Leveraging an extensive network, we ensure clients access a diverse pool of skilled professionals, tailored to meet their unique team requirements.

Our targeted recruitment framework focuses on matching candidates to specific client needs, from specialised technical roles to high-level leadership positions. Spearhunt's experts craft strategies to identify individuals with the exact skills, experience, and qualifications essential for success.

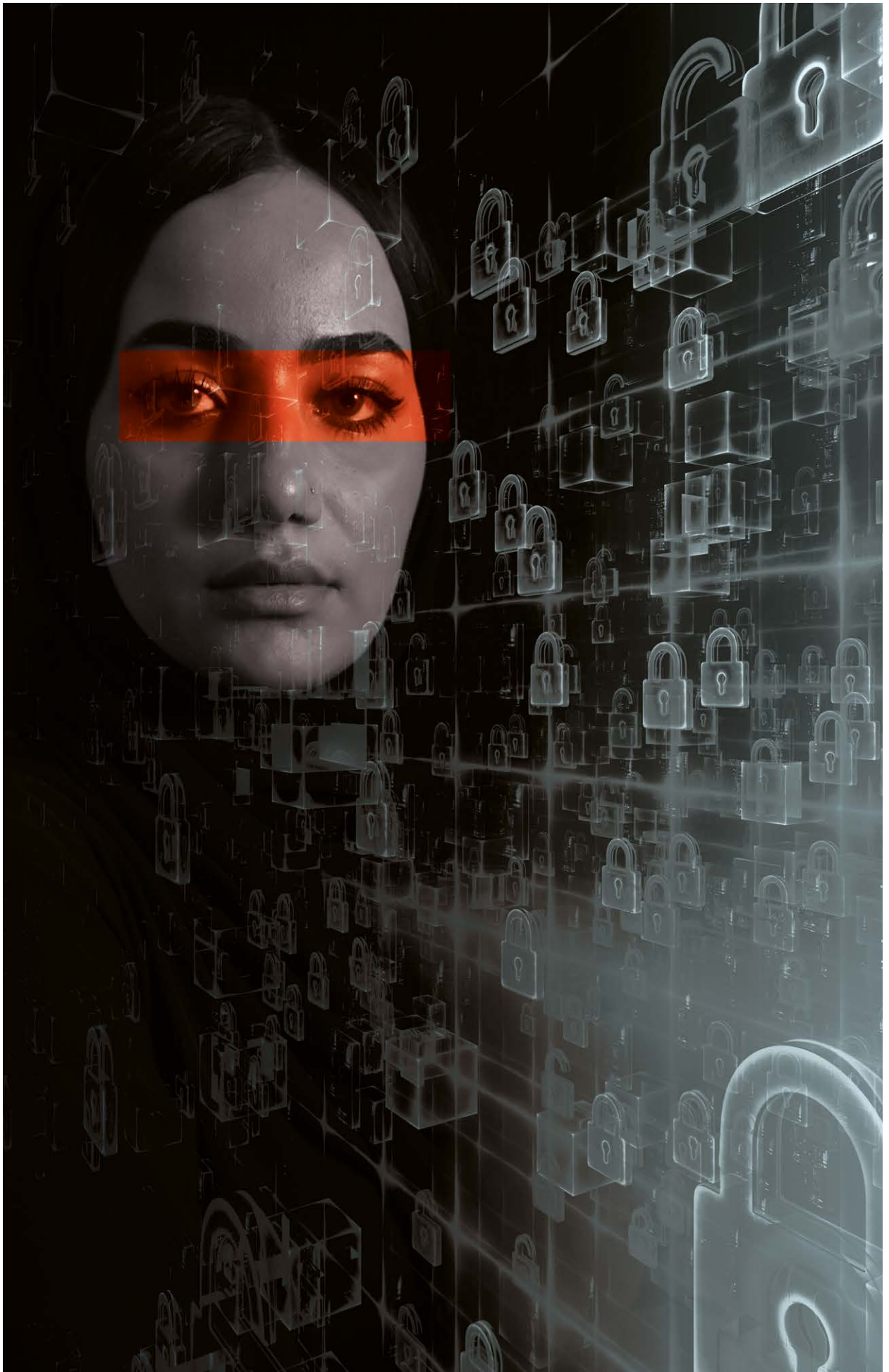



## TRAINING & SERVICES

### SERVICES

# HORIZON

## ENGLISH LANGUAGE PROFICIENCY

### TRAINING

The fully accredited HORIZON English Language Proficiency (ELP) test enables pilots to fulfil their GCAA licence requirements.



FLYER

## PILOT TRAINING

### SINGLE ENGINE HELICOPTERS

#### PRIVATE PILOT LICENCE - HELICOPTER (PPL)

The PPL enables you to act as helicopter pilot-in-command for personal flight.

#### COMMERCIAL PILOT LICENCE - HELICOPTER (CPL)

We train pilots to operate single-engine helicopters on a commercial basis. This entry level course takes students from zero flying hours all the way to the GCAA CPL (H) licence, with no previous flying experience required.

#### FLIGHT INSTRUCTOR - HELICOPTER (FI)\*

This advanced course provides pilots with the ability to instruct students to licence standard.

#### QUALIFIED MILITARY PILOT BRIDGE COURSE - HELICOPTER (QMP)

In this course, we train qualified military pilots to enable them to obtain the GCAA CPL (H) / CPL - IR (H) licence.

#### INSTRUMENT RATING (IR)

This programme trains pilots in Instrument Rating standards, which is required for any pilot to fly under Instrument Flight Rules (IFR).

#### TYPE RATING (TR)

This conversion course is designed to familiarise the pilot with the aerodynamics, mechanics, technology, operation, performance and emergency procedures of a certain aircraft type.

#### NIGHT RATING (NR)

Our Night Rating programme trains qualified and licensed pilots to safely operate a helicopter at night.



CATALOGUE

\* Required Type Rating



## TRAINING & SERVICES

### SERVICES

# HORIZON

## PILOT TRAINING

### TWIN-ENGINE HELICOPTERS

#### AIR TRANSPORT PILOT LICENSE ATPL (H)

The aim of our ATPL (H) integrated course is to train pilots to operate as a co-pilot on multi-pilot multi-engine helicopters in commercial air transport.

#### INSTRUMENT RATING (TWIN ENGINE)

The IR (H) modular flying training course trains pilots to operate helicopters under IFR and in Instrument Meteorological Conditions (IMC).

#### TWIN-ENGINE CONVERSION AND MULTI-CREW COORDINATION (MILITARY)

This course enhances the capability of pilots to perform operational missions and to function as a team, led by the pilot in command. It also provides pilots with the skills and knowledge to safely operate helicopters in a multi-pilot environment.

#### TYPE RATING (TR)

This conversion course is designed to familiarise the pilot with aircraft type.

#### NIGHT VISION GOGGLES (NVG)

This course trains pilots to operate a helicopter safely at night using Night Vision Goggles.





TRAINING & SERVICES

SERVICES

**HORIZON**

## GENERAL AVIATION COURSES

FLIGHT SAFETY

AVIATION GROUND SAFETY

AIRCRAFT ACCIDENT INVESTIGATION AND MANAGEMENT

AVIATION MANAGEMENT

CREW RESOURCE MANAGEMENT

MANAGEMENT OF FLIGHT SAFETY AND ACCIDENT INVESTIGATION

FLIGHT SAFETY OFFICER









## TRAINING & SERVICES

### SERVICES

**LAHAB**  
MILITARY SERVICES

## LAB SERVICES

### ENGINEERING LAB

At LAHAB MILITARY SERVICES, our comprehensive technical support and engineering expertise covers process design, product design and development, plant design, safety analyses, and technology transfer, and a host of others technical services for the defence and security sector.

### TRAINING LAB

Our UK-accredited training courses in Ammunition Management for activity and processes before, during and after manufacturing are among the region's most comprehensive. Run by fully qualified and highly experienced international experts, we can provide training in the UAE or at your own facilities worldwide.

Your staff need continuous training and development where it matters most. Which is why our in-depth courses enable you to understand, manage, maintain, store, transport and dispose of your ammunition safely and efficiently in accordance with ammunition best practice and the International Ammunition Technical Guidelines.

Our training courses include:

Ammunition and Explosives Foundation Course, Ammunition Technician, Ammunition and Explosives Storage Management, Ammunition and Explosives Transportation, EOD Certification, HAZMAT, Firing Officers Course, Explosive Facilities Licensing, Range and Proof Officers Course, Ammunition Surveillance, Ammunition Manufacturing and more. We also design tailor-made training to suit your specific operational requirements.

### TESTING LAB

At LAHAB MILITARY SERVICES, our dedicated facilities for ammunition and components testing are among the best staffed and equipped in the MENA region.

Training Our UK-accredited training courses in Ammunition Management for activity and processes before, during and after manufacturing are among the region's most comprehensive. Run by fully qualified and highly experienced international experts, we can provide training in the UAE or at your own facilities worldwide.

- X-Ray Laboratory Our X-Ray laboratory undertakes full X-Ray inspection of a wide range of ammunition and components in order to ensure safety and quality. Our X-Ray technology is able to analyse large munitions such as aircraft munitions.
- Testing Range At LAHAB MILITARY SERVICES, our own purpose-built test range can perform a multitude of tests on raw materials, components, protective materials and complete products including most types of ammunition. Delivered by experts following international standards, we can also arrange custom-designed tests to fulfil any special requirements. Tests requiring larger operating areas can be performed using our mobile test range.

### SIMULATION LAB

From safety traces analyses and blast overpressure analyses, to internal, external and terminal ballistic analysis, we have the talents and technologies to perform computational simulation, providing analyses for the most diverse range of situations and applications.



BROCHURE



VIDEO



## TRAINING & SERVICES

### SERVICES

**LAHAB**  
MILITARY SERVICES

## SERVICE LIFE SURVEILLANCE

At LAHAB MILITARY SERVICES, we have high-level capability in Service Life Surveillance – covering the entire ammunition lifecycle. From ammunition handling, storing and transporting to utilisation, we can help you not only to stay safe and secure, but to extend the serviceable life of your resources and maximise its value over time by testing, evaluating and recommending the optimal course of action. We can also support you in implementing your own SLS protocols so you can make the most informed decisions.

### TESTING

As part of our SLS offering, we test and trial ammunition per lot, per location, with comprehensive suite of tests including:

- Visual examination
- X-Ray examination (where relevant)
- Chemical analysis to measure stability and status in the lifecycle
- Dynamic evaluation (where relevant) through static and functional trials.

### INSIGHTS

Our SLS insights enable you to determine:

- Ammunition available for operation and deployment
- Ammunition safe for storage and transport
- Ammunition unsafe for storage
- Unserviceable ammunition
- Ammunition requiring refurbishment, demilitarisation or disposal
- Surplus stock planning
- Budgeting

### CONSULTING

In addition, we offer SLS consulting services including:

- Ammunition and explosives incidents and enquiries
- Ammunition management documentation

## DEMILITARISATION AND DISPOSAL

At the end of the ammunition lifecycle, we are the only local specialist to provide full demilitarisation and disposal services for military product, as well as the disposal of commercial materials including mining explosives and fireworks.

Disassembling products with care and neutralising volatile materials with environmentally-friendly processes to the highest standards, we ensure the safe and correct disposal and/or reworking of expired or unsafe ammunition and components.



## TRAINING & SERVICES

### SERVICES

# REMAYA



BROCHURE

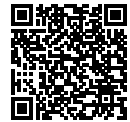

VIDEO

## XRANGE

### TEST, VERIFY, PERFORM

#### THE REGION'S ONLY MULTI- DOMAIN TRAINING, TEST AND EVALUATION RANGE

XRANGE brings flexible, multi-domain Training, Test and Evaluation (TT&E) capabilities to the heart of the Middle East. Commercial and military customers can conduct complex, air, ground and maritime trials in a secure, instrumented and ultimately, safe environment. XRANGE allows our Global clients to test and verify the performance of their platforms, systems and munitions across their lifecycle - from concept design and acquisition to through to operational upgrades. XRANGE has the ability to cater for a wide range of platforms and systems, such as unmanned air, ground and maritime platforms, through to testing mission critical sensors and Electronic Warfare systems as well as conventional munitions. Our trials are delivered with support from our highly qualified teams of Test Engineers and Subject Matter Experts and underpinned by the gathering of critical trials data via modern surveillance assets, range telemetry, RF monitoring and data acquisition systems.

#### OUR SERVICES

- Trials Design and Execution
- Test And Safety Case Management
- Range Area Provision
- Trials Data Analysis and Instrumentation
- Test Range Management
- Turnkey Testing Support

A short 100km drive from Abu Dhabi city, XRANGE is located on a highly secure, access controlled island approximately 8km offshore. It is 35km by 15km, enabling a land danger area of 355km<sup>2</sup>, inclusive of a 3.8-km-long, 60-metre-wide ICAO standard runway and a smaller 1.2KM long runway.

XRANGE provides airspace clearance up to 10,000ft which can be extended to 40,000ft when required and an additional 2,500km<sup>2</sup> of airspace can be activated via NOTAM. A 50km<sup>2</sup> sea danger area enables shallow water testing of maritime assets and systems.

Operationally accessible year-round and ideal for hot weather trials due to its arid, humid and dusty environment, the fully functional runway and ability to clear UAE customs on the island mean customers can fly directly into and out of XRANGE, simplifying logistics.



## TRAINING & SERVICES

SERVICES

REMYA



### THE ISLAND

Located 100km from Abu Dhabi city, on a highly secure 355km<sup>2</sup> island, XRANGE delivers a number of co-located facilities, support services and expert personnel to support our customers' requirements. The island enjoys favourable weather for year-round testing, offering unique advantages in assessing performance of systems and platforms in hot, humid, and dusty conditions.



## TRAINING & SERVICES

### SERVICES

# REMAVA



## CAPABILITIES

### TEST & EVALUATION

#### Air Trials

- Initial Flight Testing and Characterisation
- Live-Fire Weapons Release
- Short Range Air Defence Trials
- Payload Integration and Acceptance Testing
- Beyond Line of Sight Communication and Data Links
- UAV Endurance
- Helicopter Crew Served Weapons
- Aerial Delivery System Trials

#### Land Trials

- Fixed and Vehicle-Mounted Firing Range
- Long Range Small Arms Munitions Testing
- Large-Calibre Gunfire (Direct Role)
- Short-Range Indirect Fire Munitions
- Static Explosives Testing (ARENA)
- Directed-Energy Weapons Testing

#### Maritime Trials

- Surface Platform Performance
- Sub-Surface Platform Performance

- Anti-Surface and Sub-Surface Weapons Testing
- Naval Navigation and Communications Testing
- Mine Countermeasure Training
- Unmanned Systems Integration Trials
- Manned-Unmanned Teaming (MUM-T)
- Naval Gunfire Support (NGS) Trials

#### Electronic Warfare

- Simulation of GPS or GNSS-Denied Environments
- Jamming and Spoofing
- Suitable For ECM, ECCM, ESM Trials and Training

#### Training

- Force-On-Force Exercises (OPFOR)
- Urban Operations Rehearsal
- Close Quarter Battle Training
- Vehicle Ant-Ambush and Defensive Driving
- Amphibious Assault Exercises
- Airborne Insertion Exercises



## TRAINING & SERVICES

### SERVICES

# ADASI



BROCHURE

## SKYEDGE ACADEMY

### WORLD-CLASS TRAINING IN FPV DRONE OPERATIONS, UAVS AND OTHER AUTONOMOUS SYSTEMS

The ADASI SKYEDGE Academy equips UAE soldiers, Special Forces, and military graduates with unmatched skills in FPV drone operations. It provides them with a tactical edge in the field through hands-on training and cutting-edge AR/VR simulations. Participants learn to harness the power of FPV drones, as well as UAVs and other autonomous systems.

The curricula incorporate feedback from the UAE Armed Forces, ensuring UAE leadership in industry innovation and operational excellence. As well, a comprehensive tracking system monitors student performance, skill progression, and real-time status

#### Training location

- Al Ain REMAYA Curricula
- Turnkey solutions for UAV, FPV and autonomous systems training and development
- Active combat training to deliver tactical advantage for Special Forces
- Training and deployment of autonomous aerial systems
- Advanced facilities leverage AR/VR training sessions
- Incorporates feedback from UAE Armed Forces, ensuring UAE leadership, innovation and operational excellence in the UAV field
- Comprehensive tracking system monitors student performance, skill progression, and real-time status

**EDGE**



# HOMELAND SECURITY

**ETIMAD**  
HOMELAND SECURITY



# HOMELAND SECURITY

Harnessing advanced technologies to help customers protect borders, critical infrastructure and public safety through the design, deployment and operation of sophisticated hardware, software and systems solutions.





## HOMELAND SECURITY

### PRODUCT

**ETIMAD**  
HOMELAND SECURITY



### ANPR

The ETIMAD ANPR is a hardware-software solution for gate security, surveillance, monitoring and search. ANPR captures vehicle license plate images, converts them into digital text, and stores the data for use by law enforcement, and applications providing access control, parking management, and toll collection.

**Camera dimensions (L x W x H):**

395 mm x 120.8 mm x 127.8 mm

**Resolution:** 4 MP

**Illuminators:** Dual

**Focal length:** 2.7 mm-12 mm



FLYER



FLYER

### MSU – MOBILE SURVEILLANCE UNIT

The ETIMAD MSU is an on-road and offroad mobile surveillance unit installed on a commercial four-wheel-drive truck. Equipped with radars and electro-optical infrared sensors, it is an ideal solution for ground surveillance, including as a gap filler, temporary surveillance of a blind spot and/or part of an operation to augment and expand coverage of a fixed-surveillance sensor network.

**Chevrolet Silverado (L x W x H):** 6,759mm x 2,063mm x 2,039mm

**Vehicle Platform:** Chevrolet Silverado or Ford F-350

**Height:** 6 m (mast above ground level when deployed)

**Deployment time:** Less than 3 minutes

**Operation time:** 12 hours on batteries only (50 kWh); 24+ hours with battery-diesel generator combo

**Sensor suite:** Phased Array 2-D Pulse Doppler Radar; Cooled MWIR Electro-Optic Infrared Observation system



## HOMELAND SECURITY

### PRODUCT

**ETIMAD**  
HOMELAND SECURITY



### TYRE KILLER / ETK

The ETIMAD ETK is a tyre-puncture and vehicle disablement barrier designed to prevent unauthorised wheeled vehicle entry into restricted areas or access-controlled entry/egress routes. The system also provides an effective deterrent against vehicle-based threats.

**Length:** 1,000 mm

**Width:** 290 mm

**Height:** 110 mm



FLYER

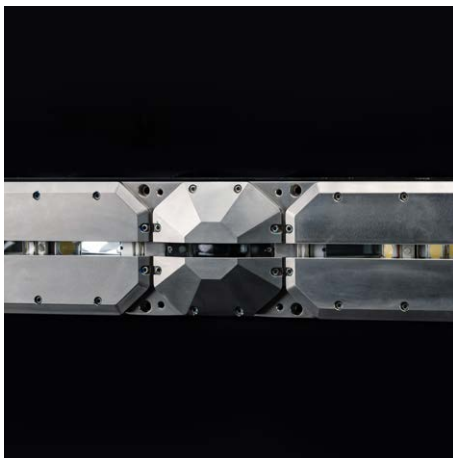

### EUVSS

The ETIMAD EUVSS provides high-quality imaging of the entire vehicle undercarriage for comprehensive gate security. Using high-resolution cameras and sensors, EUVSS captures detailed images that can be analysed within 2-3 seconds for potential explosives, weapons, or contraband.

- High-resolution undercarriage imaging
- Auto digital line scan
- 2-3 second decision response time
- Wide vision for use on diverse vehicle sizes
- Imaging and analysis conducted on moving vehicles
- Different vehicle speeds accommodated



FLYER



## HOMELAND SECURITY

### PRODUCT

**ETIMAD**  
HOMELAND SECURITY

### HS-350

The ETIMAD HS-350 is a high-speed threat simulation training drone. Manufactured of composite material, the platform is ideal for radar detection training. The drone has a 5kg payload weight, allowing it to carry a range of training systems and sensors.

**Wingspan:** 2.3 m

**Length:** 1.8 m

**Height:** 0.4 m

**MTOW:** +30 kg

**Maximum speed:** 350 km/h

**Cruising speed:** 280 km/h

**Operating ceiling:** 20,000 ft

**Maximum ceiling:** 25,000 ft

**Endurance:** 40 minutes

**Payload weight:** +5 kg

**Engine:** 22 kg thrust (jet)

### VSC-521

The ETIMAD VSC-521 provides a secure, encrypted end-to-end voice conference solution that protects voice and video conferencing, calls and screen sharing. With both ECECC-521 bit and AES-256 bit security, the solution features industry-standard and military-grade encryption

- Video and audio conferences
- End-to-end encryption
- Industry-standard and military-grade encryption
- Easy registration
- Low-bandwidth codec
- H-264 video codec
- Supports HD quality



## HOMELAND SECURITY

### PRODUCT

**ETIMAD**  
HOMELAND SECURITY

## LONG-RAIL MOBILE LAUNCHER

The ETIMAD Long-Rail Mobile Launcher is a portable drone catapult launcher capable of propelling a wide range of drones up to 150 kg at speeds up to 27.5 m/s.

**Dimensions (L x W x H):** 7m x 2m x 3m

**Metal frame**

**Elevation:** Up to 12°

**Compatible platform weight:** up to 150 kg

**Launch speed:** up to 10 m/s

## CIPHER-GATE

The ETIMAD Cipher-Gate is a portable hardware-only solution that provides secure point-to-point communication – from video and audio calling to transfer of encrypted files.

**Dimension (L x W x H):** 22 cm x 22 cm x 12 cm

**Encryption:** End-to-end

**Communication protocols:** Compatible with standard and custom protocols

**Connectivity:** Supports Ethernet networks at multiple speeds (100/1000 Mbps)

**Processing:** Hardware-based solution. No software-only encryption



FLYER



## HOMELAND SECURITY

### PRODUCT

**ETIMAD**  
HOMELAND SECURITY

## OMNISHIELD

The ETIMAD OmniShield is a centralised data integration and management platform that brings together resources, communication, and operational oversight to help enable seamless operation of diverse functions, including law enforcement, emergency response, border control, land and coastal monitoring, critical infrastructure monitoring, defence and intelligence.

- Centralised data integration
- Advanced communication system
- AI-powered decision support
- Multi-sensor fusion
- Cybersecurity and resilience
- Modular and scalable design
- Public and private partnership integration



FLYER

## PE-02

The ETIMAD PE-02 is a long-range threat simulation training drone. Manufactured of composite material, the platform is ideal for radar detection training. The drone has a 10kg payload weight, allowing it to carry a range of training systems and sensors.

**Wingspan:** 2.6 m

**Length:** 3 m

**Height:** 0.6 m

**MTOW:** +110 kg

**Maximum speed:** 240 km/h

**Cruising speed:** 170 km/h

**Operating ceiling:** 10,000 ft

**Maximum ceiling:** 12,000 ft

**Endurance:** +8 hours

**Payload weight:** +10 kg

**Engine:** 20 hp



FLYER



## HOMELAND SECURITY

### PRODUCT

**ETIMAD**  
HOMELAND SECURITY

### SKYBOLT

The ETIMAD Skybolt is a 3D-printed, fully electric Vertical Take-Off and Landing (VTOL) aircraft designed for surveillance and security monitoring, reconnaissance, and air defence training. It features multi-mode control capabilities, including 4G, manual, and GPS-based autonomous operation, ensuring reliability and efficiency in diverse training applications.

**Dimensions (L x W x H):** 3.2m x 2.5m x 0.6 m

**Propulsion:** Electric motor

**Control modes:** 4G network, manual, and autonomous GPS based navigation

**Payload:** Up to 2 kg

**Range:** 50 km (on a single charge)

**Endurance:** 80 minutes of continuous operation

**Materials:** Lightweight 3-D-printed composites



FLYER

### SPF100

The ETIMAD SPF100 is a stationary, multi-sensor anti-drone station capable of detecting, identifying, tracking and intercepting remote intrusions by unmanned aerial vehicles. Providing 360-degree coverage, the solution features radar and PTZ data fusion, with full frequency and coverage and reactive intelligent jamming.

- End-to-end anti-drone station, 360-degree coverage
- Radar and PTZ data fusion
- Full frequency and coverage and reactive intelligent jamming
- +300 drones in the database (continuously updating)



FLYER



## HOMELAND SECURITY

### PRODUCT

**ETIMAD**  
HOMELAND SECURITY

### WiSPR

The ETIMAD WiSPR is a comprehensive maritime command, control, communications and computers (C4) platform that leverages AQ-DNR (Advanced Quality Dynamic Noise Reduction) to deliver clear, noise-free communications onboard naval vessels and vehicles.

- Leading-edge Dynamic Noise Reduction (DNR) technology
- Real-time, intra-vessel ad-hoc voice, data and video communications over copper, fibre, Radio Software Defined Tactical Radio interface (SDTRI)
- Seamless software-controlled radio integration
- RoIP (Radio over IP) technology
- Seamless integration with legacy and modern vehicle subsystems for Health and Usage Monitoring Systems (HUMS) over CAN BUS, Serial, Ethernet



BROCHURE





**EDGE HQ**

Channel Street  
P.O. Box: 43221  
Abu Dhabi, UAE

[edgegroup.ae](http://edgegroup.ae)

© EDGE Group PJSC 2025. All rights reserved.

